

GROUP 31

WHEEL AND TYRE

CONTENTS

GENERAL INFORMATION	31-2	ON-VEHICLE SERVICE	31-8
SERVICE SPECIFICATIONS	31-2	TYRE INFLATION PRESSURE CHECK...	31-8
TROUBLESHOOTING	31-3	TYRE WEAR CHECK	31-8
DIAGNOSIS	31-3	WHEEL RUNOUT CHECK	31-8
WHEEL BALANCE ACCURACY	31-4	WHEEL AND TYRE	31-8
		INSTALLATION SERVICE POINT	31-8

GENERAL INFORMATION

M1311000100509

The wheels and tyres of the following specifications have been established.

SPECIFICATIONS**ROAD WHEEL AND TYRE**

Item		LS	VR, VR-X	RALLIART
Wheel	Type	Steel type	Aluminium type	Aluminium type
	Size	14 × 5.5JJ	15 × 6JJ	16 × 6.5JJ
	Amount of wheel offset mm	46	46	43
	PCD mm	100	100	114.3
Tyre	Size	175/65R14 82S	185/55R15 81V	205/45R16 83W

NOTE: PCD indicates the pitch circle diameter of the wheel installation holes.

SPARE WHEEL AND TYRE

Item		LS, VR	VR-X	RALLIART
Spare wheel	Type	Steel type	Steel type	Steel type
	Size	14 × 4T	15 × 4T	15 × 3.5B
	Amount of wheel offset mm	38	46	40
	PCD mm	100	100	114.3
Spare tyre	Size	T115/70D14 88M	T125/70D15 95M	T125/70D15 95M

NOTE: PCD indicates the pitch circle diameter of the wheel installation holes.

SERVICE SPECIFICATIONS





M1311000300570

Item		Limit
Tread depth of tyre mm		Minimum 1.6
Wheel runout <Steel wheel>	Radial runout mm	1.2 or less
	Lateral runout mm	1.2 or less
Wheel runout <Aluminium wheel>	Radial runout mm	1.0 or less
	Lateral runout mm	1.0 or less

TROUBLESHOOTING

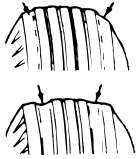
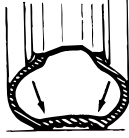
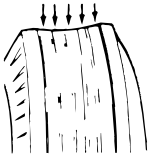
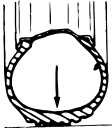
DIAGNOSIS

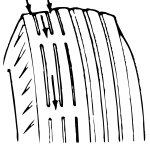
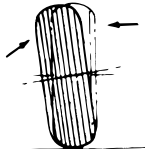
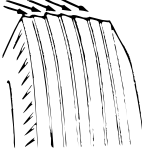
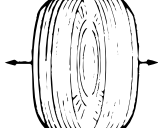
M1311000700619

Symptom	Probable cause	Remedy	Reference page	
Rapid wear at shoulders  ACX00923AB	Under-inflation or lack of rotation  ACX00924AE	Adjust the tyre pressure.	For tyre inflation pressure, refer to the label on the driver's side centre pillar.	
Rapid wear at centre  ACX00925AE	Over-inflation or lack of rotation  ACX00926AI			
Cracked treads  ACX00927AB	Under-inflation	Adjust the tyre pressure.		
Wear on one side  ACX00928AB	Excessive camber	 ACX00929AE	Check the camber.	Refer to GROUP 33, On-vehicle service – Front wheel alignment check and adjustment P.33-5 .
Feathered edge  ACX00930AB	Incorrect toe-in	 ACX00931AE	Adjust the toe-in.	
Bald spots  ACX00932AB	Unbalanced wheel	 ACX00933AB	Balance the wheel.	P.31-4

Symptom		Probable cause	Remedy	Reference page
Scalloped wear	 ACX00934	Lack of rotation of tyre or worn or out-of-alignment suspension	Rotate the tyre, and check the front suspension alignment.	Refer to GROUP 33, On-vehicle service – Front wheel alignment check and adjustment P.33-5 .

WHEEL BALANCE ACCURACY

M1311001700452

PURPOSE

This section contains tips and procedures for achieving accurate wheel balance. Steering wheel vibration and/or body shake can result if any of these procedures are not carefully observed.

1. Wheels and tyres must be properly mounted on a balancer in order to achieve correct balance. Centring the wheel on the shaft of the balancer is essential for proper mounting.
2. Off-the-car wheel balancers must be calibrated periodically to ensure good balancing results. An inaccurately calibrated balancer could cause unnecessary replacement of tyres, shocks, suspension components, or steering components.

Check your balancer's calibration approximately every 100 balances. Your wheel balancer's instruction manual should include calibration procedures. If the calibration procedures specifically for your balancer are missing, use the generic steps in this section for zero calibration, static balance, and dynamic balance checks. The wheel balancer calibration checks are also described in the flowchart (Refer to [P.31-7](#)).

PROCEDURE <BALANCING TIPS>

1. Confirm that the balancer's cone and the wheel mounting cone are undamaged and free of dirt and rust.
2. On this vehicle, the wheel's centre hole on the hub side has a chamfered edge. Use a back-mounting cone on your wheel balancer to centre the wheel on the balancer shaft.
3. Install a wheel mounting cone. The appropriate size cone for this vehicle is 56.0 mm.
4. Before balancing the wheel, remove any wheel weights from both sides. Also check both sides for any damage.
5. When installing wheel weights, hammer them at a straight (not diagonal) angle.

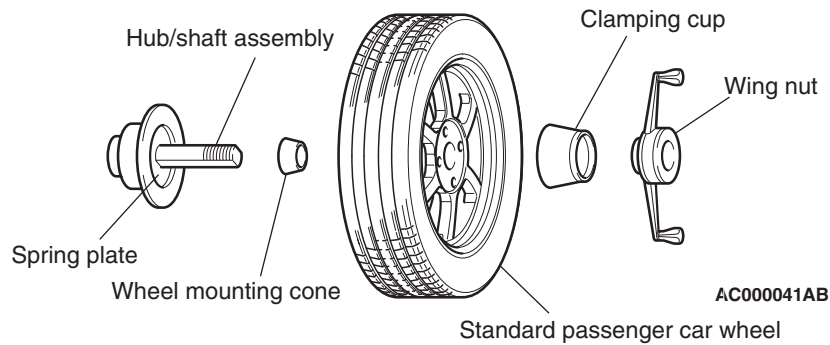

<CONFIRMING PROPER BALANCE>

1. After balancing the wheel, loosen the wing nut and turn the wheel 180° against the balancer's hub. Then re-tighten the wing nut and check the balance again. Repeat wheel balance if necessary.
2. Turn the wheel again 180° against the balancer's hub. If the wheel becomes out-of-balance each time it is turned against the balancer's hub, the wheel balancer may require calibration.

<WHEEL BALANCER CALIBRATION CHECKS>

1. Mount an undamaged original-equipment alloy rim and tyre assembly (wheel) onto your off-the-car wheel balancer. Balance the wheel.
2. <<Zero Calibration Check>>

Loosen the balancer wing nut, rotate the wheel a half-turn (180°), and retighten the nut. Recheck the balance.

 - If the imbalance is 5 g or less, the zero calibration is OK. Rebalance the wheel, then go to Step 4 to check static balance.
 - If the imbalance is more than 5 g, go to Step 3.
3. Loosen the balancer wing nut, rotate the wheel 1/4 turn (90°), and retighten the nut. Recheck the wheel balance.
 - If the imbalance is 5 g or less, the wheel may not be centred on the balancer, or the balancing cones, the cup, and/or wing nut are damaged, dirty, or inappropriate for the wheel. You may need to refer to the balancer manufacturer's instructions to verify the correct attachments. After making the necessary corrections, recheck the wheel balance. If OK, then go to Step 4.
 - If the imbalance is more than 5 g, the balancer requires calibration. Contact the balancer manufacturer for calibration by their repair representative.
4. <<Static Balance Check>>

Attach a 5 g weight to the outer rim. Recheck the balancer. The balancer should detect 5 ± 2 g of imbalance 170 to 190° away from the 5 g weight.

 - If the imbalance is within specification, the static balance calibration is correct. Go to Step 5 to check the dynamic balance.
 - If the imbalance is out of specification, the balancer requires calibration. Contact the balancer manufacturer for calibration by their repair representative.
5. <<Dynamic Balance Check>>

Attach a 5 g weight to the inner rim at 180° opposite the 5 g weight that was added in Step 4. Recheck the balance. The balancer should detect 5 ± 2 g of imbalance 170 to 190° away from both the inner and outer 5 g weights.

 - If the imbalance is within specification, the dynamic balance calibration is correct. The balancer calibration checks are complete.
 - If the imbalance is out of specification, the balancer requires calibration. Contact the balancer manufacturer for calibration by their repair representative.

WHEEL BALANCER CALIBRATION
CHECKING FLOW CHART

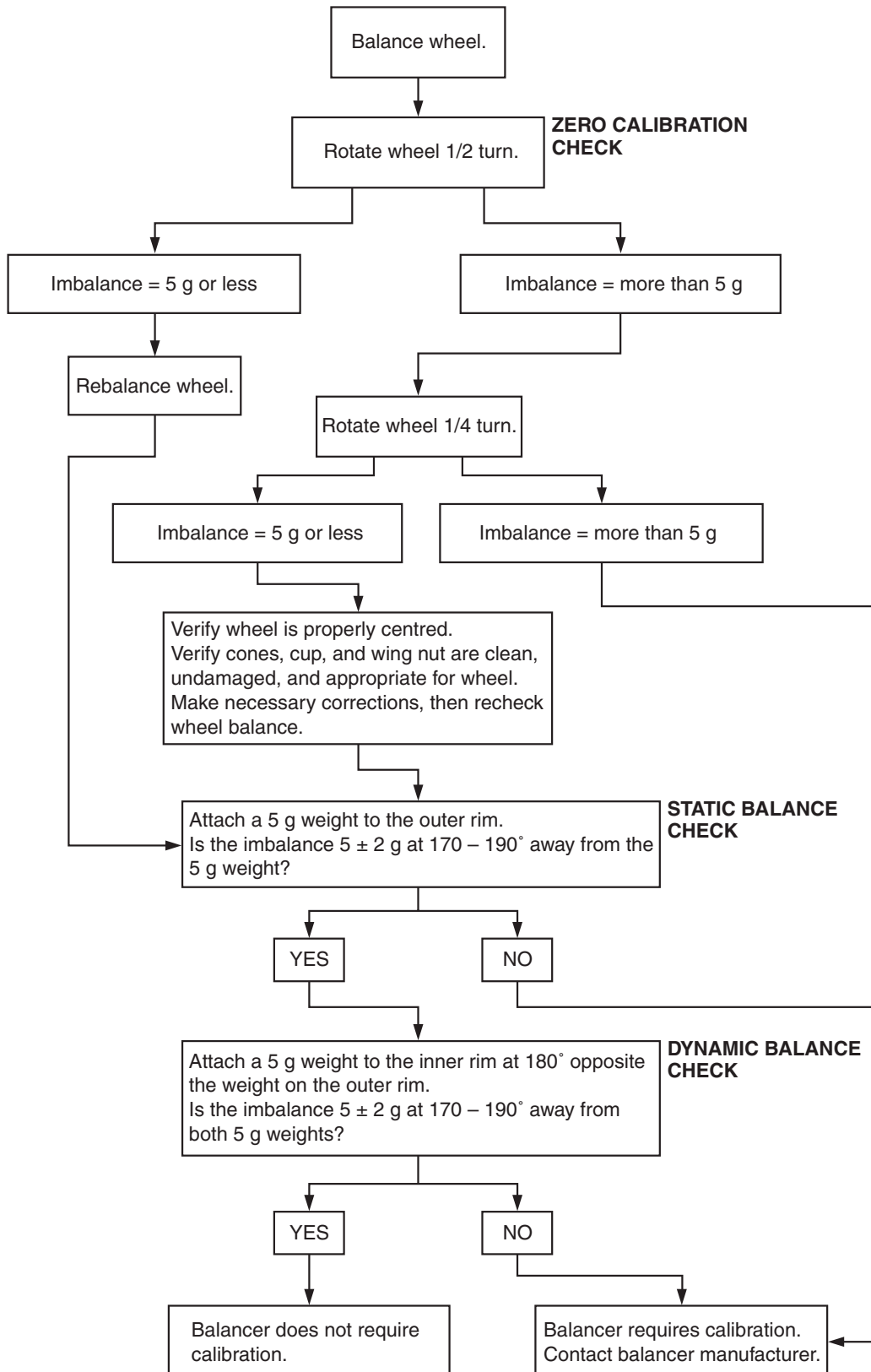

ON-VEHICLE SERVICE**TYRE INFLATION PRESSURE CHECK**

M1311000900475

NOTE: For information on tyre inflation pressure, refer to the label attached to the centre pillar on the driver's side.

TYRE WEAR CHECK

M1311001000538

Measure the tread depth of the tyres.

Minimum limit: 1.6 mm

If the remaining tread depth is less than the minimum limit, replace the tyre.

NOTE: When the tread depth of the tyres is reduced to 1.6 mm or less, wear indicators will appear.

WHEEL RUNOUT CHECK

M1311001100524

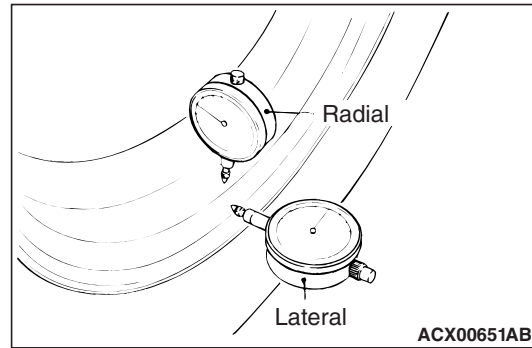

Jack up the vehicle so that the wheels are clear of the floor. While slowly turning the wheel, measure wheel runout with a dial indicator.

LIMIT:

Item	Steel wheel	Aluminium wheel
Radial runout mm	1.2	1.0
Lateral runout mm	1.2	1.0

If wheel runout exceeds the limit, replace the wheel.

WHEEL AND TYRE**INSTALLATION SERVICE POINT**

M1311001300432

Tighten the wheel nuts to the specified torque.

Tightening torque: 98 ± 10 N·m