

BMW 3 Series



Service Manual

**M3, 318i, 323i, 325i, 328i
Sedan, Coupe and Convertible
1992, 1993, 1994, 1995, 1996, 1997, 1998**



**Bentley, Publishers
Cambridge, Massachusetts**



ROBERT BENTLEY, INC.

AUTOMOTIVE PUBLISHERS

Information that makes
the difference®

www.rb.com

1734 Massachusetts Avenue
Cambridge, MA 02138 USA
800-423-4595 / 617-547-4170
e-mail: sales@rb.com

Technical Contact Information

We value your feedback. Technical comments and suggestions are helpful to us. Please send your comments and thoughts to Bentley Publishers
e-mail: tech.bmw@rb.com

From time to time, updates may be made to this manual. A listing of updates can be found on the web at www.rb.com/updates

WARNING—Important Safety Notice

Do not use this manual unless you are familiar with basic automotive repair procedures and safe workshop practices. This manual illustrates the workshop procedures required for most service work. It is not a substitute for full and up-to-date information from the vehicle manufacturer or for proper training as an automotive technician. Note that it is not possible for us to anticipate all of the ways or conditions under which vehicles may be serviced or to provide cautions as to all of the possible hazards that may result.

The vehicle manufacturer will continue to issue service information updates and parts retrofits after the editorial closing of this manual. Some of these updates and retrofits will apply to procedures and specifications in this manual. We regret that we cannot supply updates to purchasers of this manual.

We have endeavored to ensure the accuracy of the information in this manual. Please note, however, that considering the vast quantity and the complexity of the service information involved, we cannot warrant the accuracy or completeness of the information contained in this manual.

FOR THESE REASONS, NEITHER THE PUBLISHER NOR THE AUTHOR MAKES ANY WARRANTIES, EXPRESS OR IMPLIED, THAT THE INFORMATION IN THIS BOOK IS FREE OF ERRORS OR OMISSIONS, AND WE EXPRESSLY DISCLAIM THE IMPLIED WARRANTIES OF MERCHANTABILITY AND OF FITNESS FOR A PARTICULAR PURPOSE, EVEN IF THE PUBLISHER OR AUTHOR HAVE BEEN ADVISED OF A PARTICULAR PURPOSE, AND EVEN IF A PARTICULAR PURPOSE IS INDICATED IN THE MANUAL. THE PUBLISHER AND AUTHOR ALSO DISCLAIM ALL LIABILITY FOR DIRECT, INDIRECT, INCIDENTAL OR CONSEQUENTIAL DAMAGES THAT RESULT FROM ANY USE OF THE EXAMPLES, INSTRUCTIONS OR OTHER INFORMATION IN THIS BOOK. IN NO EVENT SHALL OUR LIABILITY WHETHER IN TORT, CONTRACT OR OTHERWISE EXCEED THE COST OF THIS MANUAL.

Your common sense and good judgment are crucial to safe and successful service work. Read procedures through before starting them. Think about whether the condition of your car, your level of mechanical skill, or your level of reading comprehension might result in or contribute in some way to an occurrence which might cause you injury, damage your car, or result in an unsafe repair. If you have doubts for these or other reasons about your ability to perform safe repair work on your car, have the work done at an authorized BMW dealer or other qualified shop.

Part numbers listed in this manual are for identification purposes only, not for ordering. Always check with your authorized BMW dealer to verify part numbers and availability before beginning service work that may require new parts.

Before attempting any work on your BMW, read the warnings and cautions on pages vii and viii, and any warning or caution that accompanies a procedure in the service manual. Review the warnings and cautions on pages vii and viii each time you prepare to work on your BMW.

Special tools required to perform certain service operations are identified in the manual and are recommended for use. Use of tools other than those recommended in this service manual may be detrimental to the car's safe operation as well as the safety of the person servicing the car.

Copies of this manual may be purchased from most automotive accessories and parts dealers specializing in BMW automobiles, from selected booksellers, or directly from the publisher by mail.

The publisher encourages comments from the reader of this manual. These communications have been and will be carefully considered in the preparation of this and other manuals. Please write to Robert Bentley, Inc., Publishers at the address listed on the top of this page.

This manual was published by Robert Bentley, Inc., Publishers. BMW has not reviewed and does not vouch for the accuracy of the technical specifications and procedures described in this manual.

Library of Congress Cataloging-in-Publication Data

BMW 3 Series Service Manual M3, 318i, 323i, 325i, 328i, Sedan, Coupe and Convertible:

1992, 1993, 1994, 1995, 1996, 1997, 1998.

p. cm.

Includes index.

ISBN 0-8376-0326-9

1. BMW 3 Series automobile--Maintenance and repair--Handbooks, manuals,

etc. I. Robert Bentley, inc.

TL215.B25B56 1999

629.28' 722--dc21

99-17179

CIP

Bentley Stock No. B398

Editorial closing 01/99

03 02 01 00 99 10 9 8 7 6 5 4 3 2

The paper used in this publication is acid free and meets the requirements of the National Standard for Information Sciences-Permanence of Paper for Printed Library Materials. ∞

©Copyright 1999 Robert Bentley, Inc.

All rights reserved. All information contained in this manual is based on the information available to the publisher at the time of editorial closing. The right is reserved to make changes at any time without notice. No part of this publication may be reproduced, stored in a retrieval system, or transmitted in any form or by any means, electronic, mechanical, photocopying, recording, or otherwise, without the prior written consent of the publisher. This includes text, figures, and tables. All rights reserved under Berne and Pan-American Copyright conventions.

Manufactured in the United States of America

0 General Data and Maintenance

- 010 Fundamentals for the Do-It-Yourself Owner
- 020 Maintenance Program

1 Engine

- 100 Engine-General
- 110 Engine Removal and Installation
- 113 Cylinder Head Removal and Installation
- 116 Cylinder Head and Valvetrain
- 117 Camshaft Timing Chain
- 119 Lubrication System
- 120 Ignition System
- 121 Battery, Starter, Alternator
- 130 Fuel Injection
- 160 Fuel Tank and Fuel Pump
- 170 Radiator and Cooling System
- 180 Exhaust System

2 Transmission

- 200 Transmission-General
- 210 Clutch
- 230 Manual Transmission
- 240 Automatic Transmission
- 250 Gearshift Linkage
- 260 Driveshaft

3 Suspension, Steering and Brakes

- 300 Suspension, Steering and Brakes-General
- 310 Front Suspension
- 320 Steering and Wheel Alignment
- 330 Rear Suspension
- 331 Final Drive
- 340 Brakes

4 Body

- 400 Body-General
- 410 Fenders, Engine Hood
- 411 Doors
- 412 Trunk Lid

5 Body Equipment

- 510 Exterior Trim, Bumpers
- 512 Door Windows
- 513 Interior Trim
- 515 Central Locking and Anti-Theft
- 520 Seats
- 540 Sunroof
- 541 Convertible Top

6 Electrical System

- 600 Electrical System-General
- 610 Electrical Component Locations
- 611 Wipers and Washers
- 612 Switches and Electrical Accessories
- 620 Instruments
- 630 Exterior Lighting
- 640 Heating and Air Conditioning
- 650 Radio

7 Equipment and Accessories

- 720 Seat Belts
- 721 Airbag System (SRS)

Electrical Wiring Diagrams

Automotive Books From Robert Bentley

BMW SERVICE MANUALS

BMW 7 Series Service Manual: 1988-1994
735i, 735iL, 740i, 740iL, 750iL
Robert Bentley ISBN 0-8376-0328-5

BMW 3 Series Service Manual: 1992-1998
M3, 318i, 323i, 325i, 328i, Sedan, Coupe and
Convertible Robert Bentley
ISBN 0-8376-0326-9

BMW Z3 Service Manual: 1996-1998
4-cylinder and 6-cylinder models
Robert Bentley ISBN 0-8376-0327-7

BMW 3-Series Service Manual: 1984-1990
318i, 325, 325e(es), 325i(is), and 325i
Convertible Robert Bentley
ISBN 0-8376-0325-0

BMW 5-Series Service Manual: 1989-1995
525i, 530i, 535i, 540i including Touring
Robert Bentley ISBN 0-8376-0319-6

BMW 5-Series Service Manual: 1982-1988
528e, 533i, 535i, 535is Robert Bentley
ISBN 0-8376-0318-8

ENTHUSIAST TITLES

**Complete Roundel 1969-1998: 30 Years of
the Magazine of the BMW Car Club of
America (CD-ROM)** ISBN 0-8376-0322-6

**Unbeatable BMW: Eighty Years of
Engineering and Motorsport Success**
Jeremy Walton ISBN 0-8376-0206-8

BMW 6 Series Enthusiast's Companion™
Jeremy Walton ISBN 0-8376-0149-5

**BMW Enthusiast's Companion™ BMW
Car Club of America** ISBN 0-8376-0321-8

**BMW Notecards Series 1 Photography by
Klaus Schnitzer** ISBN 0-8376-0211-4

**A French Kiss With Death: Steve
McQueen and the Making of Le Mans**
Michael Keyser ISBN 0-8376-0234-3

**The Speed Merchants: A Journey Through
The World of Motor Racing, 1969-72**
Michael Keyser ISBN 0-8376-0232-7

**Mustang 5.0 Technical Reference &
Performance Handbook**
Al Kirschenbaum ISBN 0-8376-0210-6

**Maximum Boost: Designing, Testing, and
Installing Turbocharger Systems**
Corky Bell ISBN 0-8376-0160-6

**Volkswagen Sport Tuning
for Street and Competition**
Per Schroeder ISBN 0-8376-0161-4

Sports Car and Competition Driving
Paul Frère with foreword by Phil Hill
ISBN 0-8376-0202-5

**The Design and Tuning of Competition
Engines Philip H. Smith, 6th edition revised by
David N. Wenner** ISBN 0-8376-0140-1

**Going Faster: The Skip Barber Racing
School Carl Lopez** ISBN 0-8376-0227-0

**Think To Win Don Alexander with foreword
by Mark Martin** ISBN 0-8376-0070-7

**The Technique of Motor Racing Piero
Taruffi with foreword by Juan Manuel Fangio**
ISBN 0-8376-0228-9

Race Car Aerodynamics
Joseph Katz ISBN 0-8376-0142-8

**The Scientific Design of Exhaust and
Intake Systems Philip H. Smith and John C.
Morrison** ISBN 0-8376-0309-9

Volkswagen Model Documentation
Joachim Kuch ISBN 0-8376-0078-2

Volkswagen Beetle: Portrait of a Legend
Edwin Baaske ISBN 0-8376-0162-2

**Glory Days: When Horsepower and
Passion Ruled Detroit**
Jim Wangers ISBN 0-8376-0208-4

Alfa Romeo Owner's Bible™
Pat Braden with foreword by Don Black
ISBN 0-8376-0707-9

Ford F-Series Pickup Owner's Bible™
Moses Ludel ISBN 0-8376-0152-5

**Harley-Davidson Evolution V-Twin
Owner's Bible™ Moses Ludel**
ISBN 0-8376-0146-0

Jeep Owner's Bible™
Moses Ludel ISBN 0-8376-0154-1

**Toyota Truck & Land Cruiser Owner's
Bible™ Moses Ludel** ISBN 0-8376-0159-2

The Racing Driver Denis Jenkinson
ISBN 0-8376-0201-7

FUEL INJECTION

**Ford Fuel Injection and Electronic Engine
Control: 1988-1993 Charles O. Probst, SAE**
ISBN 0-8376-0301-3

**Ford Fuel Injection and Electronic Engine
Control: 1980-1987 Charles O. Probst, SAE**
ISBN 0-8376-0302-1

**Bosch Fuel Injection and Engine
Management Charles O. Probst, SAE**
ISBN 0-8376-0300-5

VOLKSWAGEN OFFICIAL SERVICE MANUALS

New Beetle Service Manual: 1998-1999
Robert Bentley ISBN 0-8376-0385-4

**Jetta, Golf, GTI, Cabrio Service Manual:
1993-early 1999, including VR6 and TDI**
Robert Bentley ISBN 0-8376-0366-8

**Eurovan Official Factory Repair Manual:
1992-1999 Volkswagen of America**
ISBN 0-8376-0335-8

**Volkswagen Inspection/Maintenance
(I/M) Emission Test Handbook: 1980-1997**
Volkswagen of America ISBN 0-8376-0394-3

**Passat Official Factory Repair Manual:
1995-1997 Volkswagen of America**
ISBN 0-8376-0380-3

**GTI, Golf, and Jetta Service Manual: 1985-
1992 Gasoline, Diesel, and Turbo Diesel,
including 16V Robert Bentley**
ISBN 0-8376-0342-0

**Corrado Official Factory Repair Manual:
1990-1994 Volkswagen United States**
ISBN 0-8376-0387-0

**Passat Service Manual: 1990-1993,
including Wagon Volkswagen United States**
ISBN 0-8376-0378-1

**Cabriolet and Scirocco Service Manual:
1985-1993, including 16V**
Robert Bentley ISBN 0-8376-0362-5

**Volkswagen Fox Service Manual: 1987-
1993, including GL, GL Sport and Wagon**
Robert Bentley ISBN 0-8376-0363-3

**Rabbit, Scirocco, Jetta Service Manual:
1980-1984 Gasoline Models, including
Pickup Truck, Convertible, and GTI Robert
Bentley** ISBN 0-8376-0183-5

**Rabbit, Jetta Service Manual: 1977-1984
Diesel Models, including Pickup Truck
and Turbo Diesel Robert Bentley**
ISBN 0-8376-0184-3

**Super Beetle, Beetle and Karmann Ghia
Official Service Manual Type 1: 1970-1979**
Volkswagen United States ISBN 0-8376-0096-0

**Beetle and Karmann Ghia Official Service
Manual Type 1: 1966-1969 Volkswagen
United States** ISBN 0-8376-0416-8

AUDI SERVICE MANUALS

**Audi 100, A6 Official Factory Repair
Manual: 1992-1997, including S4, S6,
quattro and Wagon models.**
Audi of America. ISBN 0-8376-0374-9

**Audi 80, 90, Coupe Quattro Official
Factory Repair Manual: 1988-1992
including 80 Quattro, 90 Quattro and
20-valve models Audi of America**
ISBN 0-8376-0367-6

**Audi 100, 200 Official Factory Repair
Manual: 1988-1991 Audi of America**
ISBN 0-8376-0372-2

**Audi 5000S, 5000CS Official Factory
Repair Manual: 1984-1988 Gasoline,
Turbo, and Turbo Diesel, including Wagon
and Quattro Audi of America** ISBN 0-8376-
0370-6

**Audi 5000, 5000S Official Factory Repair
Manual: 1977-1983 Gasoline and Turbo
Gasoline, Diesel and Turbo Diesel**
Audi of America ISBN 0-8376-0352-8

**Audi 4000S, 4000CS, and Coupe GT
Official Factory Repair Manual: 1984-1987
including Quattro and Quattro Turbo Audi
of America** ISBN 0-8376-0373-0

SAAB OFFICIAL SERVICE MANUALS

**Saab 900 16 Valve Official Service Manual:
1985-1993 Robert Bentley** ISBN 0-8376-0312-9

**Saab 900 8 Valve Official Service Manual:
1981-1988 Robert Bentley** ISBN 0-8376-0310-2

VOLVO SERVICE MANUAL

Volvo 240 Service Manual: 1983-1993
Robert Bentley ISBN 0-8376-0285-8



Robert Bentley has published service manuals and automobile books since 1950. Please write Robert Bentley, Inc., Publishers, at 1734 Massachusetts Avenue, Cambridge, MA 02138, visit our web site at <http://www.rb.com>, or call 1-800-423-4595 for a free copy of our complete catalog, including titles and service manuals for Jaguar, Triumph, Austin-Healey, MG, and other cars.

Foreword

This service manual covers 1992 through 1998 BMW 3 Series models, and is specifically designed to cover only those models built for sale in the United States.

BMW, and most accessories and parts sellers specializing in BMWs, refer to the 3 Series cars covered by this manual as the E36 model. The code "E36" is BMW's internal code for the basic platform shared by all of the cars covered by this manual. Except for the engine and a few other components, the models covered by this manual share many of same components such as suspension parts, body panels, and the interior pieces. When ordering parts, especially body parts, knowing the E36 code may be helpful.

BMW also uses an internal code for the engines used in the 3 Series models. Consult the text in the **100 Engine—General** repair group of this manual for a complete listing of engine codes. Engine code information is primarily used internally by BMW, but may be helpful if you have access to BMW technical information.

For the BMW owner with basic mechanical skills, this manual gives detailed maintenance and repair information. In addition, the BMW owner who has no intention of working on his or her own car will find that owning and reading this manual will make it possible to be better informed and to discuss repairs more intelligently with a professional technician. This manual has been prepared from the repair information that BMW provides to its factory-trained technicians and has been developed primarily with the do-it-yourself BMW owner in mind. The aim throughout has been clarity and understanding with practical descriptions, step-by-step procedures, and accurate specifications.

The BMW owner intending to do maintenance and repair should have a set of tools including a set of metric wrenches and sockets, screwdrivers, a torque wrench, and feeler gauges, since these basic tools will be used to do the majority of the maintenance and repair procedures described in this manual. This manual includes detailed information on these basic tools and other tips for the beginner in the first section of the manual, entitled **010 Fundamentals for the Do-It-Yourself Owner**. For some of the repairs described in this manual, BMW technicians use special tools. The text will note when a repair requires these special tools and, where possible, will recommend practical alternatives.

We have endeavored to ensure the highest degree of accuracy possible. When the vast array of data presented in the manual is taken into account, however, no claim to infallibility can be made. We therefore cannot be responsible for the result of any errors that may have crept into the text. The publisher encourages comments from the readers of this manual with regard to any errors and, also, suggestions for improvement in the presentation of technical material. These communications have been and will be carefully considered in the preparation of future printings of this and other manuals. Please contact Robert Bentley, Inc. using the contact information on the copyright page at the beginning of this manual.

BMW offers extensive warranties, especially on components of the fuel delivery and emissions control systems. Therefore, before deciding to repair a BMW that may still be covered wholly or in part by any warranties issued by BMW of North America, consult your authorized BMW dealer. You may find that he can make the repair either free or at minimum cost.

Regardless of its age and whether or not it is still protected by warranty, your BMW is an easy car to get serviced. So if at any time a repair is needed that you feel is too difficult to do yourself, a trained BMW technician is ready to do the job for you. Each authorized BMW dealer service department has made a significant investment in service and diagnostic test equipment, special tools, and BMW original parts. It is also the best source of the most up-to-date repair and service techniques, which includes factory training and technical literature. Servicing your BMW through an authorized BMW dealer will insure that your investment will be protected while maintaining the highest degree of service standards.

Robert Bentley

Please read these warnings and cautions before proceeding with maintenance and repair work.

WARNING—

- See also Cautions on page viii
- Some repairs may be beyond your capability. If you lack the skills, tools and equipment, or a suitable workplace for any procedure described in this manual, we suggest you leave such repairs to an authorized BMW dealer service department or other qualified shop.
- Do not re-use any fasteners that are worn or deformed in normal use. Many fasteners are designed to be used only once and become unreliable and may fail when used a second time. This includes, but is not limited to, nuts, bolts, washers, self-locking nuts or bolts, circlips and cotter pins. Always replace these fasteners with new parts.
- Never work under a lifted car unless it is solidly supported on stands designed for the purpose. Do not support a car on cinder blocks, hollow tiles or other props that may crumble under continuous load. Never work under a car that is supported solely by a jack. Never work under the car while the engine is running.
- If you are going to work under a car on the ground, make sure that the ground is level. Block the wheels to keep the car from rolling. Disconnect the battery negative (–) terminal (ground strap) to prevent others from starting the car while you are under it.
- Never run the engine unless the work area is well ventilated. Carbon monoxide kills.
- Finger rings, bracelets and other jewelry should be removed so that they cannot cause electrical shorts, get caught in running machinery, or be crushed by heavy parts.
- Tie long hair behind your head. Do not wear a necktie, a scarf, loose clothing, or a necklace when you work near machine tools or running engines. If your hair, clothing, or jewelry were to get caught in the machinery, severe injury could result.
- Do not attempt to work on your car if you do not feel well. You increase the danger of injury to yourself and others if you are tired, upset or have taken medication or any other substance that may keep you from being fully alert.
- Illuminate your work area adequately but safely. Use a portable safety light for working inside or under the car. Make sure the bulb is enclosed by a wire cage. The hot filament of an accidentally broken bulb can ignite spilled fuel or oil.
- Catch draining fuel, oil, or brake fluid in suitable containers. Do not use food or beverage containers that might mislead someone into drinking from them. Store flammable fluids away from fire hazards. Wipe up spills at once, but do not store the oily rags, which can ignite and burn spontaneously.
- Always observe good workshop practices. Wear goggles when you operate machine tools or work with battery acid. Gloves or other protective clothing should be worn whenever the job requires working with harmful substances.
- Greases, lubricants and other automotive chemicals contain toxic substances, many of which are absorbed directly through the skin. Read the manufacturer's instructions and warnings carefully. Use hand and eye protection. Avoid direct skin contact
- Disconnect the battery negative (–) terminal (Ground strap) whenever you work on the fuel system or the electrical system. Do not smoke or work near heaters or other fire hazards. Keep an approved fire extinguisher handy.
- Friction materials (such as brake pads or shoes or clutch discs) contain asbestos fibers or other friction materials. Do not create dust by grinding, sanding, or by cleaning with compressed air. Avoid breathing dust. Breathing any friction material dust can lead to serious diseases and may result in death.
- Batteries give off explosive hydrogen gas during charging. Keep sparks, lighted matches and open flame away from the top of the battery. If hydrogen gas escaping from the cap vents is ignited, it will ignite gas trapped in the cells and cause the battery to explode.
- Connect and disconnect battery cables, jumper cables or a battery charger only with the ignition switched off, to prevent sparks. Do not disconnect the battery while the engine is running.
- Do not quick-charge the battery (for boost starting) for longer than one minute. Wait at least one minute before boosting the battery a second time.
- Do not allow battery charging voltage to exceed 16.5 volts. If the battery begins producing gas or boiling violently, reduce the charging rate. Boosting a sulfated battery at a high charging rate can cause an explosion.
- The air-conditioning system is filled with chemical refrigerant, which is hazardous. The A/C system should be serviced only by trained technicians using approved refrigerant recovery/recycling equipment, trained in related safety precautions, and familiar with regulations governing the discharging and disposal of automotive chemical refrigerants.
- Do not expose any part of the A/C system to high temperatures such as open flame. Excessive heat will increase system pressure and may cause the system to burst.
- Some aerosol tire inflators are highly flammable. Be extremely cautious when repairing a tire that may have been inflated using an aerosol tire inflator. Keep sparks, open flame or other sources of ignition away from the tire repair area. Inflate and deflate the tire at least four times before breaking the bead from the rim. Completely remove the tire from the rim before attempting any repair.
- Cars covered by this manual are equipped with a supplemental restraint system (SRS), that automatically deploys an airbag(s) in the event of a frontal impact. The airbag(s) is inflated by an explosive device. Handled improperly or without adequate safeguards, can be accidentally activated and cause serious injury.
- The ignition system produces high voltages that can be fatal. Avoid contact with exposed terminals and use extreme care when working on a car with the engine running or the ignition switched on.
- Place jack stands only at locations specified by manufacturer. The vehicle lifting jack supplied with the vehicle is intended for tire changes only. A heavy duty floor jack should be used to lift vehicle before installing jack stands. See **010 Fundamentals for the Do-it-Yourself Owner**.
- Battery acid (electrolyte) can cause severe burns. Flush contact area with water, seek medical attention.
- Aerosol cleaners and solvents may contain hazardous or deadly vapors and are highly flammable. Use only in a well ventilated area. Do not use on hot surfaces (engines, brakes, etc.).
- Do not remove coolant reservoir or radiator cap with the engine hot. Danger of burns and engine damage.

continued on next page
vii

Please read these warnings and cautions before proceeding with maintenance and repair work.

CAUTION—

- See also Warnings on page vii
- If you lack the skills, tools and equipment, or a suitable workshop for any procedure described in this manual, we suggest you leave such repairs to an authorized BMW dealer or other qualified shop.
- BMW is constantly improving its cars and sometimes these changes, both in parts and specifications, are made applicable to earlier models. Therefore, part numbers listed in this manual are for reference only. Always check with your authorized BMW dealer parts department for the latest information.
- Before starting a job, make certain that you have all the necessary tools and parts on hand. Read all the instructions thoroughly, do not attempt shortcuts. Use tools appropriate to the work and use only replacement parts meeting BMW specifications. Make-shift tools, parts and procedures will not make good repairs.
- Use pneumatic and electric tools only to loosen threaded parts and fasteners. Never use these tools to tighten fasteners, especially on light alloy parts. Always use a torque wrench to tighten fasteners to the tightening torque specification listed.
- Be mindful of the environment and ecology. Before you drain the crankcase, find out the proper way to dispose of the oil. Do not pour oil onto the ground, down a drain, or into a stream, pond or lake. Dispose of in accordance with Federal, State and Local laws.
- If battery power is lost or the battery has been disconnected, the power windows must be re-initialized. Both one touch up/down and pinch-protection will be inactive until windows are re-initialized. See **512 Door Windows**.
- The control module for the anti-lock brake system (ABS) cannot withstand temperatures from a paint-drying booth or a heat lamp in excess of 203°F (95°C) and should not be subjected to temperatures in excess of 185°F (85°C) for more than two hours.
- Before doing any electrical welding on cars equipped with ABS, disconnect the battery negative (-) terminal (ground strap) and the ABS control unit connector.
- On cars equipped with anti-theft radios, make sure you know the correct radio activation code before disconnecting the battery or removing the radio. If the wrong code is entered into the radio when power is restored, that radio may lock up and be rendered inoperable, even if the correct code is then entered.
- Always make sure ignition is off before disconnecting battery.
- Label battery cables before disconnecting. On some models, battery cables are not color coded.
- Disconnecting the battery may erase fault code(s) stored in control module memory. Using special BMW diagnostic equipment, check for fault codes prior to disconnecting the battery cables. If the Check Engine light is illuminated, see **100 Engine-General** for On-Board Diagnostics (OBD) fault code information. If any other system faults have been detected (indicated by an illuminated warning light), see an authorized BMW dealer.
- If a normal or rapid charger is used to charge battery, the battery must be disconnected and removed from the vehicle in order to avoid damaging paint and upholstery.
- Do not quick-charge the battery (for boost starting) for longer than one minute. Wait at least one minute before boosting the battery a second time.
- Connect and disconnect a battery charger only with the battery charger switched off.
- Sealed or "maintenance free" batteries should be slow-charged only, at an amperage rate that is approximately 10% of the battery's ampere-hour (Ah) rating.
- Do not allow battery charging voltage to exceed 16.5 volts. If the battery begins producing gas or boiling violently, reduce the charging rate. Boosting a sulfated battery at a high charging rate can cause an explosion.



010 Fundamentals for the Do-It-Yourself Owner

GENERAL	010-1	TOOLS	010-8
HOW TO USE THIS MANUAL	010-2	Basic Tool Requirements	010-8
Warnings, Cautions and Notes	010-2	Jack Stands	010-9
GETTING STARTED	010-2	Oil Change Equipment	010-9
Safety	010-2	Torque Wrench	010-10
Lifting the Car.	010-3	Feeler Gauges	010-10
Raising car safely.	010-3	Digital Multimeter	010-10
Working under car safely.	010-4	BMW Special Tools.....	010-11
ADVICE FOR THE BEGINNER	010-4	EMERGENCIES	010-11
Planning Ahead	010-4	Changing a Tire	010-11
Cleanliness.	010-4	Car Will Not Start	010-11
Non-reusable Fasteners.....	010-5	Jump Starting Car.....	010-12
Tightening Fasteners	010-5	Overheating	010-12
Gaskets and Seals.....	010-5	Low Oil Pressure.....	010-13
Electrical Testing	010-6	Brake Fluid Level	010-13
Wire Repairs	010-6	Check Engine Warning Light	010-13
BUYING PARTS	010-6	Dim Lights	010-13
Genuine BMW Parts	010-6	Towing	010-13
Non-returnable Parts	010-7	Spare Parts Kit	010-14
Information You Need to Know	010-7		
SERVICE	010-7		

TABLES

a. General Bolt Tightening Torques in Nm (max. permissible)	010-5
--	-------

GENERAL

Although the BMW is a sophisticated and complex machine, basic maintenance can be accomplished by an interested owner with mechanical skills and the right information. Most of the preventive maintenance that is required in the lifetime of the average BMW is well within the capabilities of the do-it-yourselfer.

WARNING —

Do not use this manual unless you are familiar with basic automotive repair procedures and safe workshop practices. This manual illustrates the workshop procedures required for most service work; it is not a substitute for full and up-to-date information from the vehicle manufacturer or for proper training as an automotive technician. Note that it is not possible for us to anticipate all of the ways or conditions under which vehicles may be serviced or to provide cautions as to all of the possible hazards that may result.

WARNING —

Your common sense and good judgment are crucial to safe and successful service work. Read procedures through before starting them. Think about whether the condition of your car, your level of mechanical skill, or your level of reading comprehension might result in or contribute in some way to an occurrence that might cause you injury, damage your car, or result in an unsafe repair. If you have doubts for these or other reasons about your ability to perform safe repair work on your car, have the work done at an authorized BMW dealer or other qualified shop.

This section of the manual is intended to help the beginner get started. To begin with there is a discussion on **How To Use This Manual**. Tips on mechanic's skills and workshop practices that can help the beginner do a faster and more thorough job can be found under **Getting Started**. The basic tools needed to do most of the procedures in this manual are found under **Tools**. The section ends with a quick reference guide to **Emergencies**, including basic troubleshooting and information on how to gauge the seriousness of a problem.

GENERAL

HOW TO USE THIS MANUAL

The manual is divided into nine sections:

- 0 GENERAL DATA AND MAINTENANCE
- 1 ENGINE
- 2 TRANSMISSION
- 3 SUSPENSION, STEERING AND BRAKES
- 4 BODY
- 5 BODY EQUIPMENT
- 6 ELECTRICAL SYSTEM
- 7 EQUIPMENT AND ACCESSORIES
 - ELECTRICAL WIRING DIAGRAMS

0 GENERAL DATA AND MAINTENANCE covers the recommended maintenance schedules and service procedures needed to perform BMW scheduled maintenance work. Also within this section is the **010 Fundamentals for the Do-It-Yourself Owner** section, which contains basic instructions, tips and helpful hints for do-it-yourself maintenance and repair.

The next seven sections (1 through 7) are repair based and are further broken down into three digit repair groups. Each major section begins with a **General** repair group, e.g. **100 Engine-General**. These "00" (double zero) groups are mostly descriptive in nature, covering topics such as theory of operation and troubleshooting. The remainder of the repair groups contain the more involved repair information. The last major section contains detailed electrical wiring diagram schematics.

A master listing of the 9 major sections and the corresponding individual repair groups can be found on the inside front cover.

Each repair group begins with a Table of Contents listing the major subject headings within the group. Page numbers throughout the manual are organized according to the repair group system. For example, you can expect to find repair information on brakes (Repair Group 340) beginning on page 340-1. A comprehensive index can be found at the back of the manual.

Warnings, Cautions and Notes

Throughout this manual are many passages with the headings **WARNING**, **CAUTION**, or **NOTE**. These very important headings have different meanings.

WARNING —

The text under this heading warns of unsafe practices that are very likely to cause injury, either by direct threat to the person(s) performing the work or by increased risk of accident or mechanical failure while driving.

CAUTION —

A caution calls attention to important precautions to be observed during the repair work that will help prevent accidentally damaging the car or its parts.

NOTE —

A note contains helpful information, tips that will help in doing a better job and completing it more easily.

Please read every **WARNING**, **CAUTION**, and **NOTE** at the front of the manual and as they appear in repair procedures. They are very important. Read them before you begin any maintenance or repair job.

Some **WARNINGS** and **CAUTIONS** are repeated wherever they apply. Read them all. Do not skip any. These messages are important, even to the owner who never intends to work on the car.

GETTING STARTED

Most of the necessary maintenance and minor repair that an automobile will need can be done with ordinary tools, even by owners with little or no experience in car repair. Below is some important information on how to work safely, a discussion of what tools will be needed and how to use them.

Safety

Although an automobile presents many hazards, common sense and good equipment can help ensure safety. Many accidents happen because of carelessness. Pay attention and stick to these few important safety rules.

WARNING —

- *Never run the engine in the work area unless it is well-ventilated. The exhaust should be vented to the outside. Carbon monoxide (CO) in the exhaust kills.*
- *Remove all neckties, scarfs, loose clothing, or jewelry when working near running engines or power tools. Tuck in shirts. Tie long hair and secure it under a cap. Severe injury can result from these things being caught in rotating parts.*
- *Remove rings, watches, and bracelets. Aside from the dangers of moving parts, metallic jewelry conducts electricity and may cause shorts, sparks, burns, or damage to the electrical system when accidentally contacting the battery or other electrical terminals.*
- *Disconnect the battery negative (-) cable whenever working on or near the fuel system or anything that is electrically powered. Accidental electrical contact may damage the electrical system or cause a fire.*

WARNING —

- Never work under a lifted car unless it is solidly supported on jack stands that are intended for that purpose. Do not support a car on cinder blocks, bricks, or other objects that may shift or crumble under continuous load. Never work under a car that is supported only by the lifting jack.
- Fuel is highly flammable. When working around fuel, do not smoke or work near heaters or other fire hazards. Keep an approved fire extinguisher handy.
- Illuminate the work area adequately and safely. Use a portable safety light for working inside or under the car. A fluorescent type light is best because it gives off less heat. If using a light with a normal incandescent bulb, use rough service bulbs to avoid breakage. The hot filament of an accidentally broken bulb can ignite spilled fuel or oil.
- Keep sparks, lighted matches, and any open flame away from the top of the battery. Hydrogen gas emitted by the battery is highly flammable. Any nearby source of ignition may cause the battery to explode.
- Never lay tools or parts in the engine compartment or on top of the battery. They may fall into confined spaces and be difficult to retrieve, become caught in belts or other rotating parts when the engine is started, or cause electrical shorts and damage to the electrical system.
- The fuel system is designed to retain pressure even when the ignition is off. When working with the fuel system, loosen the fuel lines slowly to allow the residual pressure to dissipate gradually. Take precautions to avoid spraying fuel.

Lifting the Car

For those repairs that require raising the car, the proper jacking points should be used to raise the car safely and avoid damage. There are four jacking points from which the car can be safely raised. The jack supplied with the car by BMW can only be used at the four side points—just behind the front wheel or just in front of the rear wheel. See Fig. 1.

WARNING —

- When raising the car using a floor jack or a hydraulic lift, carefully position the jack pad to prevent damaging the car body. A suitable liner (wood, rubber, etc.) should be placed between the jack and the car to prevent body damage.
- Watch the jack closely. Make sure it stays stable and does not shift or tilt. As the car is raised, the car may roll slightly and the jack may shift.

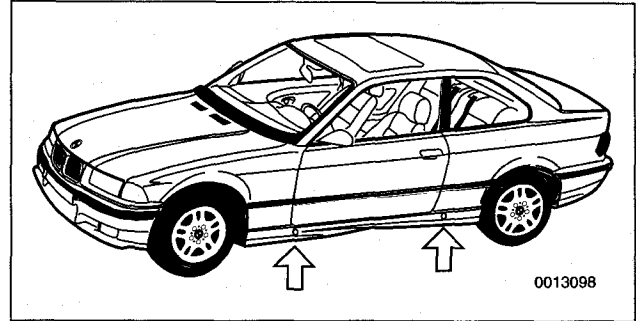

Fig. 1. 3-Series jacking points (arrows).

Raising car safely

1. Park car on flat, level surface.
2. Remove the round cover from jack mount using a screwdriver. See Fig. 2.



Fig. 2. Jack mount cover being removed from rocker panel.

3. Place jack fully into position. See Fig. 3. Make sure jack is resting on flat, solid ground. Use a board or other support to provide a firm surface for the jack, if necessary.
4. Raise car slowly while constantly checking position of jack and car.
5. Once car is raised, block the wheel that is opposite and farthest from jack to prevent car from unexpectedly rolling.

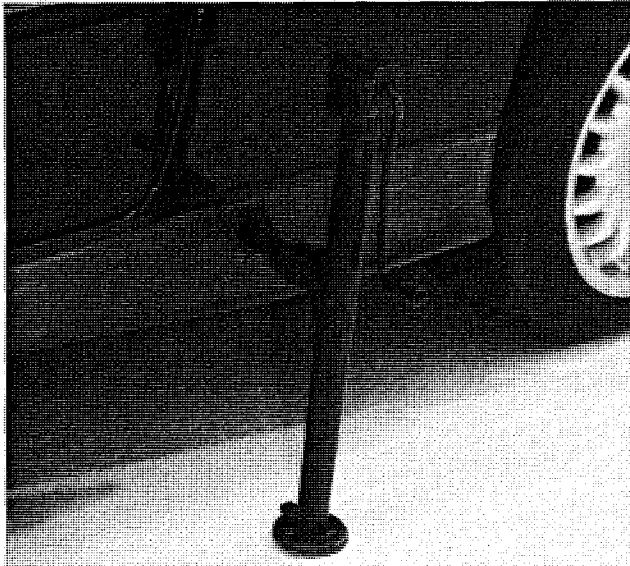

0013127

Fig. 3. BMW supplied jack correctly positioned in front jacking point.

WARNING —

- Do not rely on the transmission or the emergency brake to keep the car from rolling. They are not a substitute for positively blocking the opposite wheel.
- Never work under a car that is supported only by a jack. Use jack stands that are properly designed to support the car. See **Tools**.

Working under car safely

1. Disconnect negative (-) cable from battery so that no one else can start the car. Let others know what you will be doing.

CAUTION —

Prior to disconnecting the battery, read the battery disconnection cautions given at the front of this manual on page viii.

2. Raise car slowly as described above.
3. Use at least two jack stands to support the car. A jack is a temporary lifting device and should not be used alone to support the car while you are under it. Use jack stands designed for the purpose of supporting a car. For more information on jack stands, see **Tools** below.

WARNING —

Do not use wood, concrete blocks, or bricks to support a car. Wood may split. Blocks or bricks, while strong, are not designed for that kind of load, and may break or collapse.

4. Place jack stands on firm, solid surface. If necessary, use a flat board or similar solid object to provide a firm footing.
5. Lower car slowly until its weight is fully supported by jack stands. Watch to make sure that the jack stands do not tip or lean as the car settles on them.
6. Observe all jacking precautions again when raising car to remove jack stands.

ADVICE FOR THE BEGINNER

The tips in the paragraphs that follow are general advice to help any do-it-yourself BMW owner perform repairs and maintenance tasks more easily and more professionally.

Planning Ahead

Most of the repairs and maintenance tasks described in this manual can be successfully completed by anyone with basic tools and abilities. To prevent getting in too deep, know what the whole job requires before starting. Read the procedure thoroughly, from beginning to end, in order to know just what to expect and what parts will have to be replaced.

Cleanliness

Keeping things organized, neat, and clean is essential to doing a good job. When working under the hood, fender covers will protect the finish from scratches and other damage. Make sure the car is relatively clean so that dirt under the cover does not scratch the finish.

Any repair job will be less troublesome if the parts are clean. For cleaning old parts, there are many solvents and parts cleaners commercially available.

For cleaning parts prior to assembly, commercially available aerosol cans of parts cleaner or brake cleaner are handy to use, and the cleaner will evaporate completely.

WARNING —

Virtually all solvents used for cleaning parts are highly flammable, especially in aerosol form. Use with extreme care. Do not smoke. Do not use these products near any source of heat, sparks or flame.

Let any solvent or cleaning product dry completely. Low-pressure, dry compressed air is helpful if available. Also, use only lint-free rags for cleaning and drying.

WARNING —

Avoid getting tools or clothing near the battery. Battery electrolyte is a corrosive acid. Be careful with brake fluid, as it can damage the car's paint. Finally, keep rubber parts such as hoses and belts free from oil or gasoline, as they will cause the material to soften and fail prematurely.

Non-reusable Fasteners

Many fasteners used on the cars covered by this manual must be replaced with new ones once they are removed. These include but are not limited to: bolts, nuts (self-locking, nylock, etc.), cotter pins, studs, brake fittings, roll pins, clips and washers. Genuine BMW parts should be the only replacement parts used for this purpose.

Some bolts are designed to stretch during assembly and are permanently altered rendering them unreliable once removed. These are known as torque-to-yield fasteners. Always replace fasteners where instructed to do so. Failure to replace these fasteners could cause vehicle damage and personal injury. See an authorized BMW dealer for applications and ordering information.

Tightening Fasteners

When tightening the bolts or nuts that attach a component, it is always good practice to tighten the bolts gradually and evenly to avoid misalignment or over stressing any one portion of the component. For components sealed with gaskets, this method helps to ensure that the gasket will seal properly and completely.

Where there are several fasteners, tighten them in a sequence alternating between opposite sides of the component. Fig. 4 shows such a sequence for tightening six bolts attaching a typical component. Repeat the sequence until all the bolts are evenly tightened to the proper specification.

For some repairs a specific tightening sequence is necessary, or a particular order of assembly is required. Such special conditions are noted in the text, and the necessary sequence is described or illustrated. Where no specific torque is listed, **Table a** can be used as a general guide for tightening fasteners.

WARNING —

Table a is a general reference only. The values listed in the table are not intended to be used as a substitute for torques specifically called out in the text throughout this manual.

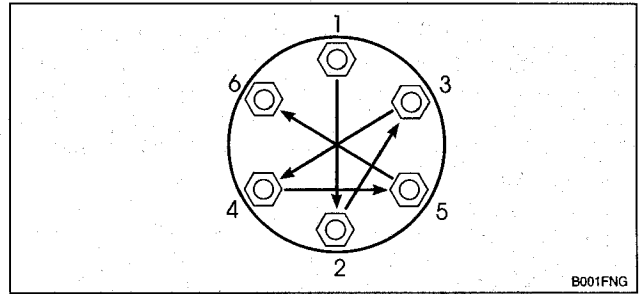

Fig. 4. General sequence for alternately tightening multiple fasteners.

NOTE —

- Metric bolt classes or grades are marked on the bolt head.
- Do not confuse wrench size with bolt diameter size. For a listing of the common wrenches used on various bolt diameters, see **Basic Tool Requirements**.

Table a. General Bolt Tightening Torques in Nm (max. permissible)

Bolt diameter	Bolt Class (according to DIN 267)					
	5.6	5.8	6.8	8.8	10.9	12.9
M5	2.5	3.5	4.5	6	8	10
M6	4.5	6	7.5	10	14	17
M8	11	15	18	24	34	40
M10	23	30	36	47	66	79
M12	39	52	62	82	115	140
M14	62	82	98	130	180	220
M16	94	126	150	200	280	340
M18	130	174	210	280	390	470

Gaskets and Seals

The smoothest metal mating surfaces still have imperfections that can allow leakage. To prevent leakage at critical joints, gaskets of soft, form-fitting material are used to fill in the imperfections.

To be most effective, gaskets are designed to crush and become thinner as the mating parts are bolted together. Once a gasket has been used, it is no longer capable of making as good a seal as when new, and is much more likely to leak. For this reason, gaskets should not be reused. Always plan to use new gaskets for any reassembly. Some gaskets—such as head gaskets—are directional. Make sure that these are installed correctly. This same logic applies to any part used for sealing, including rubber O-rings and copper sealing washers.

In places where a shaft must pass through a housing, flexible lip seals are used to keep the lubricating oil or grease from leaking out past the rotating shaft. Seals should never be reused once they have been removed. When removing a seal, be careful not to scratch or otherwise damage the metal surfaces. Even minor damage to sealing surfaces can cause seal damage and leakage.

The key to seal installation is to get the seal in straight without damaging it. Use a seal driver that is the same diameter as the seal housing to gently and evenly install into place. If a proper size seal driver is not available, a socket of the right size will do.

When installing a seal, it is a good idea to coat the seal with oil to aid installation. Some seals are directional and special installation instructions apply. Make sure it is installed with the lip facing the correct way. Normally the lip faces the inside. Note the installation direction of the old seal before removing it.

Electrical Testing

Many electrical problems can be understood and solved with only a little fundamental knowledge of how electrical circuits function.

Electric current only flows in a complete circuit. To operate, every electrical device in the car requires a complete circuit including a voltage source and a path to ground. The positive (+) side of the battery is the original voltage source, and ground is any return path to the negative (-) side of the battery, whether through the wiring harness or the car body. Except for portions of the charging system, all electrical current in the car is direct current (DC) and flows from positive (+) to negative (-).

Switches are used to turn components on or off by completing or interrupting the circuit. A switch is "open" when the circuit is interrupted, and "closed" when the circuit is completed. Fig. 5 shows a basic circuit schematic. See **600 Electrical System-General** for electrical troubleshooting.

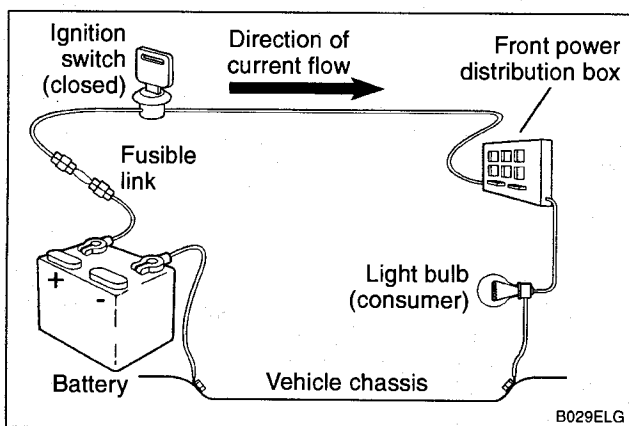

Fig. 5. Schematic representation of simple circuit for light bulb. Ignition switch is shown closed, making circuit complete.

BUYING PARTS

Wire Repairs

Repairs to a wiring harness require special care to make the repair permanent. The wire ends must be clean. If frayed or otherwise damaged, cut off the end. If the wire is too short, splice in a new piece of wire of the same size and make two connections.

Use connectors that are designed for the purpose. Crimped-on or soldered-on connectors are best. Crimp connectors and special crimping pliers are widely available. If soldering, use needlenose pliers to hold the wire near the solder joint and create a "heat dam". This keeps the heat and the solder from traveling up the wire. Always use a solder made specifically for electrical work (rosin core).

NOTE —

Twisting wires together to make a repair is not recommended. Corrosion and vibration will eventually spoil the connection and may lead to irreparable damage to sensitive electronic components.

Insulate the finished connection. Electronics stores can supply heat-shrinkable insulating tubing that can be placed onto the wire before connecting, slid over the finished joint, and shrunk to a tight fit with a heat gun or hair dryer. The next best alternative is electrical tape. Make sure the wire is clean and free of solder flux or other contamination. Wrap the joint tightly to seal out moisture. See **600 Electrical-General** for more information.

BUYING PARTS

Many of the maintenance and repair tasks in this manual call for the installation of new parts, or the use of new gaskets and other materials when reinstalling parts. Most often, the parts that will be needed should be on hand before beginning the job. Read the introductory text and the complete procedure to determine which parts will be needed.

NOTE —

For some bigger jobs, partial disassembly and inspection are required to determine a complete parts list. Read the procedure carefully and, if necessary, make other arrangements to get the necessary parts while your car is disassembled.

Genuine BMW Parts

Genuine BMW replacement parts from an authorized BMW dealer are designed and manufactured to the same high standards as the original parts. They will be the correct material, manufactured to the same specifications, and guaranteed to fit and work as intended by the engineers who designed the car. Some genuine BMW parts have a limited warranty.

Many independent repair shops make a point of using genuine BMW parts, even though they may at times be more expensive. They know the value of doing the job right with the right parts. Parts from other sources can be as good, particularly if manufactured by one of BMW's original equipment suppliers, but it is often difficult to know.

BMW is constantly updating and improving their cars, often making improvements during a given model year. BMW may recommend a newer, improved part as a replacement, and your authorized dealer's parts department will know about it and provide it. The BMW parts organization is best equipped to deal with any BMW parts needs.

Non-returnable Parts

Some parts cannot be returned for credit, even if they are the wrong parts for the car. The best example is electrical parts, which are almost universally considered non-returnable because they are so easily damaged internally.

Buy electrical parts carefully, and be as sure as possible that a replacement is needed, especially for expensive parts such as electronic control units. It may be wise to let an authorized BMW dealer or other qualified shop confirm your diagnosis before replacing an expensive part that cannot be returned.

Information You Need to Know

Model. When ordering parts it is important that you know the correct model designation for your car. Models covered in this manual are E36 3 Series in both 4- and 6-cylinder configurations.

Model Year. This is not necessarily the same as date of manufacture or date of sale. A 1997 model may have been manufactured in late 1996, and perhaps not sold until early 1997. It is still a 1997 model. Model years covered by this manual are 1992 to 1998.

Date of Manufacture. This information is helpful when ordering replacement parts or determining if any of the warranty recalls are applicable to your car. The label on the driver's door below the door latch will specify the month and year that the car was built.

Vehicle Identification Number (VIN). This is a combination of letters and numbers that identify the particular car. The VIN appears on the state registration document, and on the car itself. One location is in the rear of the engine compartment, another in the lower left corner of the windshield.

The National Highway Traffic Safety Administration (NHTSA) requires passenger cars with a high theft rate to have the VIN marked on specific parts of the car when manufactured. On BMW cars, these parts are identified by an adhesive label.

Original body panels and other large components are identified by a label bearing the VIN and two BMW roundel logos. Replacement parts have a similar label, bearing one BMW roundel logo and the letters DOT-R. See Fig. 6. Parts or assemblies bearing the label are the engine, transmission, front and rear bumpers, front fenders, rear quarter panels, hood, trunk lid and doors. These labels should not be removed as they will tear apart.

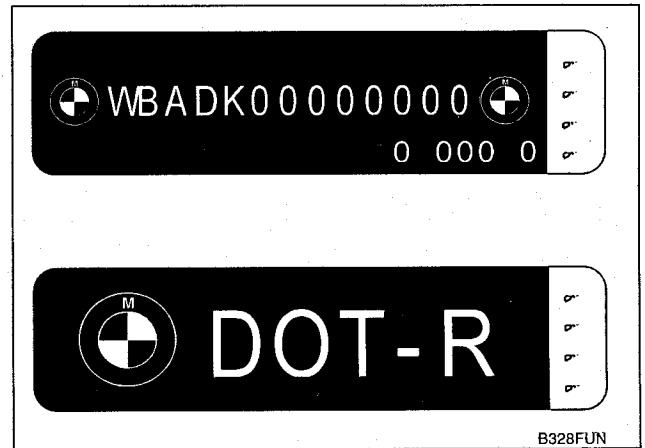

Fig. 6. Labels used to identify parts. Original equipment label with VIN number and roundel logos (top) and replacement part label with one roundel logo.

Engine. 3-Series cars covered in this manual are powered by either a 4- or 6-cylinder engine. For information on engine codes and engine applications, see **100 Engine-General**.

Transmission. The transmission type with its identifying code may be important when buying clutch parts, seals, gaskets, and other transmission-related parts. For information on transmission codes and applications, see **200 Transmission-General**.

SERVICE

BMW dealers are uniquely qualified to provide service for BMW cars. Their authorized relationship with the large BMW service organization means that they are constantly receiving new tools and equipment, together with the latest and most accurate repair information.

The BMW dealer's service technicians are highly trained and very capable. Unlike most independent repair shops, authorized BMW dealers are intensely committed to supporting the BMW product. They share the owner's interest in BMW value, performance, and reliability. On the other hand, there are many independent shops that specialize in BMW service and are capable of doing high quality repair work. Checking with other BMW owners for recommendations on service facilities is a good way to learn of reputable BMW shops in your area.

TOOLS

Most maintenance can be accomplished with a small selection of the right tools. Tools range in quality from inexpensive junk, which may break at first use, to very expensive and well-made tools for the professional. The best tools for most do-it-yourself BMW owners lie somewhere in between.

Many reputable tool manufacturers offer good quality, moderately priced tools with a lifetime guarantee. These are your best buy. They cost a little more, but they are good quality tools that will do what is expected of them. Sears' Craftsman® line is one such source of good quality tools.

Some of the repairs covered in this manual require the use of special tools, such as a custom puller or specialized electrical test equipment. These special tools are called out in the text and can be purchased through an authorized BMW dealer. As an alternative, some special tools mentioned may be purchased from the following tool manufacturers and/or distributors:

- Assenmacher Specialty Tools
6440 Odell Place, Boulder, CO 80301
(303) 530-2424
- Baum Tools Unlimited, Inc.
P.O. Box 87, Longboat Key, FL 34228
(800) 848-6657
- Schley Products Inc.
5350 E. Hunter Ave., Anaheim Hills, CA 92807
(714) 693-7666
- Zelenda Machine and Tool Corp.
66-02 Austin Street, Forest Hills, NY 11375
(718) 896-2288

Basic Tool Requirements

The basic hand tools described below can be used to accomplish most of the simple maintenance and repair tasks.

Screwdrivers. The common flat-blade type and the Phillips type will handle almost all screws used on BMWs. Two or three different sizes of each type will be required, since a screwdriver of the wrong size will damage the screw head. See Fig. 7.

A complete set of screwdrivers should also include Torx® type screwdrivers.

Wrenches. Wrenches come in different styles for different uses. Fig. 8 shows several. The basic open-end wrench is the most widely used, but grips on only two sides. It can spread apart and slip off more easily. The box-end wrench has better grip, on all six sides of a nut or bolt.

A 12-point box-end can loosen a nut or bolt where there is less room for movement, while a 6-point box-end provides better grip. For hex fasteners on fluid lines, like brake lines and fuel lines, a flare-nut wrench offers the advantages of a box-end wrench with a slot that allows it to fit over the line.

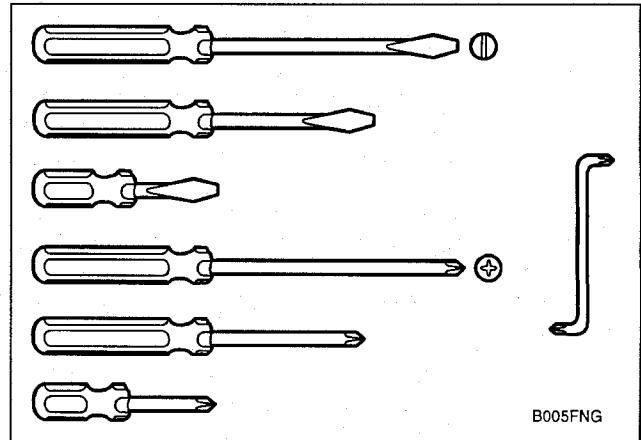

Fig. 7. Common flat-blade (top) and Phillips (bottom) screwdrivers. Offset screwdriver (right) is used for screws with limited access.

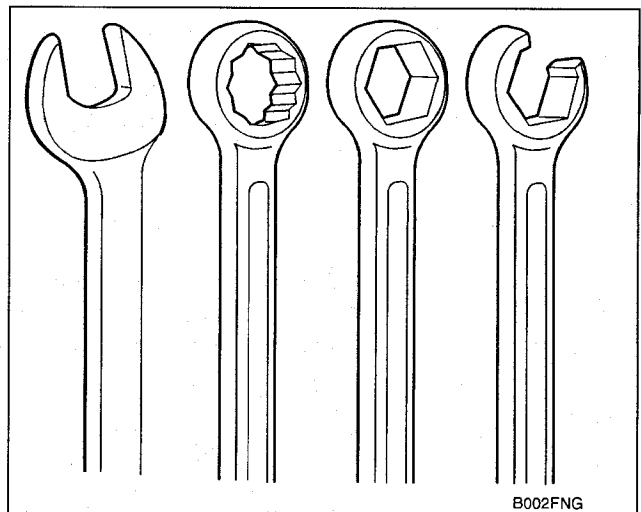

Fig. 8. Types of wrench heads. From left, open-end, 12-point box-end, 6-point box-end, flare nut.

The combination wrench is the most universal. It has one open-end and one box-end. 10mm and 13mm wrenches are the most common sizes needed. A more complete set of wrenches would include 6mm through 19mm sizes.

Sockets. Sockets perform the same job as box-end wrenches, but offer greater flexibility. They are used with a ratchet handle for speed and convenience and can be combined with extensions and universal joints (swivels) to reach fasteners more easily. Sockets come with different size connections to drive handles or extensions, called the drive size. The most common drive sizes are 1/4 in., 3/8 in., and 1/2 in.

Sockets come in 6-point and 12-point styles. For use with a ratchet, the 6-point offers a better grip on tight nuts and bolts. 6mm to 19mm sockets are the most needed sizes. Below is a list of typical bolt diameters and the corresponding wrench sizes.

Bolt Diameter and Wrench Size

• M5	8 mm
• M6	10 mm
• M8	12 mm or 13 mm
• M10	17 mm
• M12	19 mm
• M14	22 mm

Spark Plug Socket. A special socket for spark plugs is the correct size, is deep enough to accommodate a spark plug's length, and includes a rubber insert to both protect the spark plug from damage and grip it for easier removal. See Fig. 9.

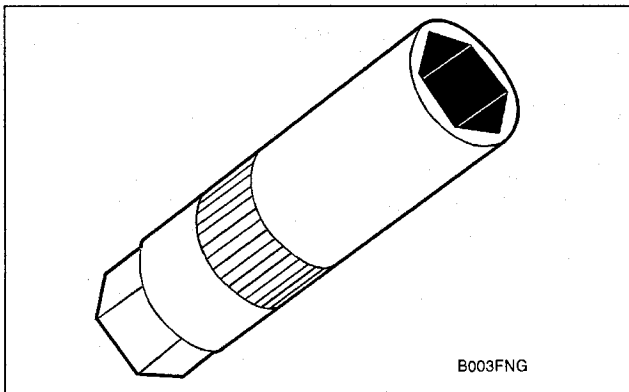

Fig. 9. Spark plug socket.

Pliers. A few of the many types of pliers are shown in Fig. 10. Most are used for holding irregular objects, bending, or crimping. Some have special applications.

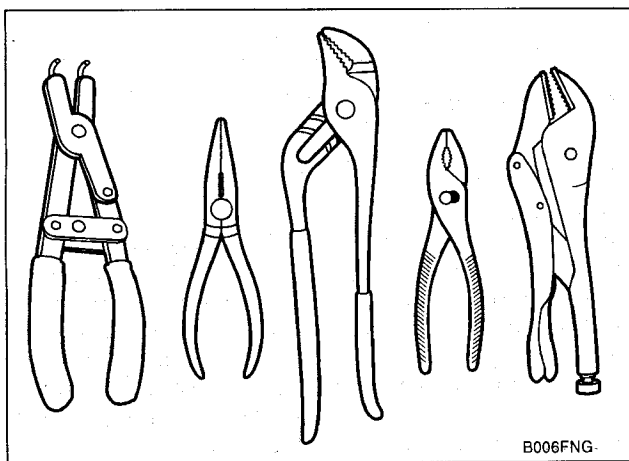

Fig. 10. Pliers. From left, snap-ring, needlenose, adjustable-joint (Channellock®), slip-joint, and locking (Vise-Grip®).

A needlenose plier is used for gripping small and poorly accessible objects, and is useful for wiring and other electrical work. A locking plier such as the Vise-Grip® is useful because of its tight grip.

Snap-ring and circlip pliers with special tipped jaws are used to remove and install snap-rings or circlips. A Channel-lock® or water pump plier has adjustable jaws that can be quickly changed to match the size of the object being held to give greater leverage.

An adjustable wrench can be a useful addition to a small tool kit. See Fig. 11. It can substitute in a pinch, if two wrenches of the same size are needed to remove a nut and bolt. Use extra care with adjustable wrenches, as they tend to loosen, slip, and damage fasteners.

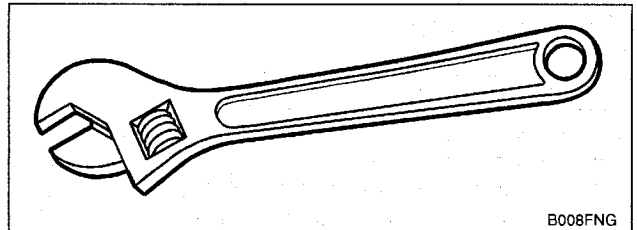

Fig. 11. Adjustable wrench.

Compared to a wrench of the correct size, an adjustable wrench is always second best. They should only be used when the correct size wrench is not available. Choose one of average size range, about 6 to 8 inches in length.

Jack Stands

Strong jack stands are extremely important for any work that is done under the car. Use only jack stands that are designed for the purpose. Blocks of wood, concrete, bricks, etc. are not safe or suitable substitutes.

WARNING —

A jack should be used only to raise the vehicle and should not be used to support the car for a long period. Always use jack stands to support a raised vehicle.

Jack stands are available in several styles. A typical jack stand is shown in Fig. 12. The best ones are made of heavy material for strength, have a wide base for stability, and are equipped to positively lock in their raised positions. Get the best ones available.

Oil Change Equipment

Changing engine oil requires a 17mm socket or wrench to loosen and tighten the drain plug and a drain pan (at least 8 qt. capacity). An oil filter wrench is not required. These items are shown in Fig. 13. A wide, low drain pan will fit more easily under the car. Use a funnel to pour the new oil into the engine.

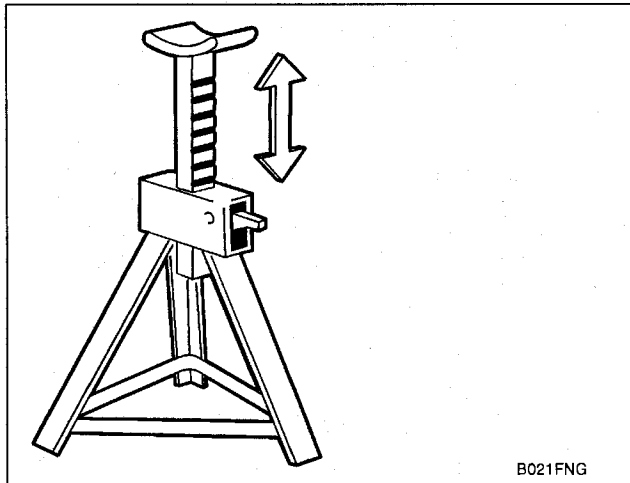

B021FNG

Fig. 12. Jack stand for safely supporting car to work underneath.

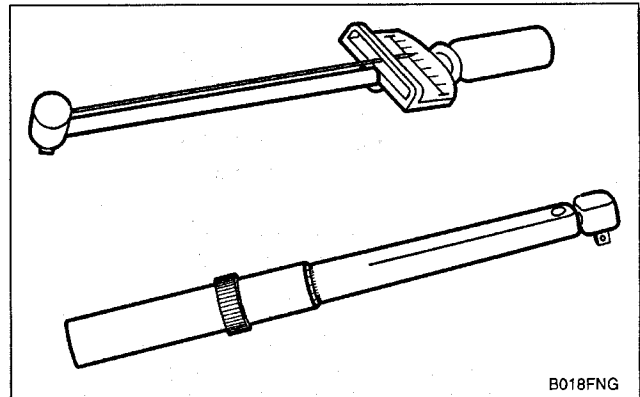

B018FNG

Fig. 14. Torque wrenches. Inexpensive beam-type (top) is adequate but must be read visually. Ratchet-type (bottom) can be preset to indicate (click) when torque value has been reached.

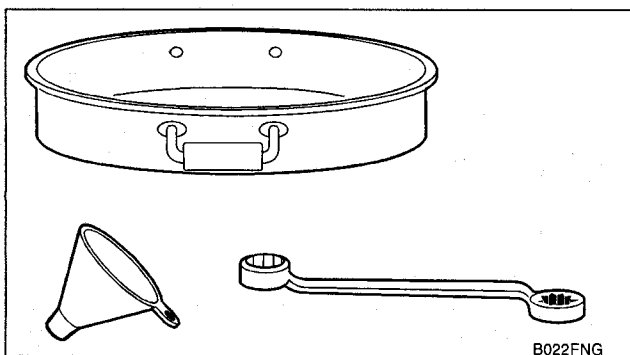

B022FNG

Fig. 13. Oil change equipment includes drain plug wrench (17mm), 8 qt. drain pan, and funnel.

Torque Wrench

A torque wrench is used to precisely tighten threaded fasteners to a predetermined value. Many of the repair procedures in this manual include BMW-specified torque values in Newton-meters (Nm) and the equivalent values in foot-pounds (ft-lb).

Several types of torque wrenches are available. They all do the same job, but offer different convenience features at different prices. Two typical torque wrenches are shown in Fig. 14. The most convenient ones have a built-in ratchet, and can be preset to indicate when a specific torque value has been reached. Follow the wrench manufacturer's directions for use to achieve the greatest accuracy.

A torque wrench with a range up to about 150 Nm (185 ft-lb) has adequate capacity for most of the repairs covered in this manual. For recommended torque values of 10 Nm or below, the English system equivalent is given in inch-lb. These small values may be most easily reached using a torque wrench calibrated in inch-pounds. To convert inch-pounds to foot-pounds, divide by 12.

Feeler Gauges

Feeler gauges are thin metal strips of precise thickness, used to measure small clearances. They are normally available as a set, covering a range of sizes. See Fig. 15.

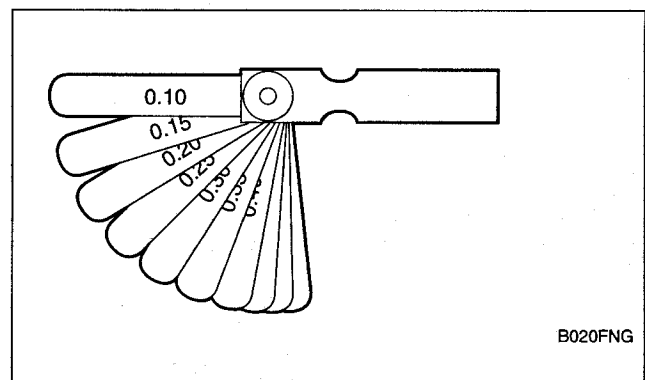

B020FNG

Fig. 15. Feeler gauge set.

Digital Multimeter

Many of the electrical tests in this manual call for the measurement of resistance (ohms) or voltage values. For safe and accurate tests of ignition, fuel injection, and emission control systems, the multi-meter, shown in Fig. 16, should be digital, with high (at least 10,000 ohms) input impedance. Some meters have automotive functions such as dwell and pulse width that are useful for troubleshooting ignition and fuel injection problems.

CAUTION —

The DME system, central body electronics, and other electronic systems may be damaged by the high current draw of a test light with a normal incandescent bulb. As a general rule, use a high impedance digital multimeter or an LED test light for all electrical testing.

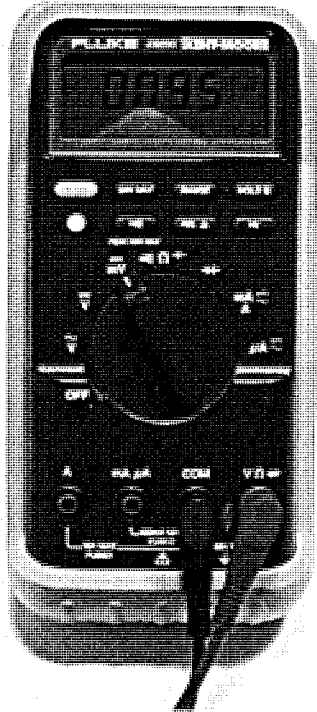

0012223

Fig. 16. Multimeter or Digital Volt/Ohmmeter (DVOM).

BMW Special Tools

Some of the more challenging repairs covered in this manual call for the use of BMW special tools. This, however, does not automatically mean that the job is too complicated or out of reach of the novice.

Many of the BMW special tools mentioned in this manual are simply the best thing to use to do the job correctly. In these cases, the tool is identified with a BMW part number. See your authorized BMW dealer parts department for information on how to order special tools.

There are some jobs for which expensive special tools are essential, and not a cost-effective purchase for one-time repair by the do-it-yourself owner. This manual includes such repairs for the benefit of those with the necessary experience and access to tools. For the do-it-yourselfer, the need for special tools is noted in the text, and whether or not BMW dealer service is recommended.

EMERGENCIES

Changing a Tire

Stop the car on as flat a surface as possible, in a place where you can be easily seen by other drivers. Avoid stopping just over the crest of a hill. Turn on the emergency flashers, and set out flares or emergency markers well behind the car. Chock the

wheel (wheel chock located in trunk) diagonally opposite to the one being changed. Passengers should get out of the car and stand well away from the road. Remove the spare tire from the spare tire storage tray, as described later.

WARNING —

If a tire goes flat while driving, pull well off the road. Changing a tire on a busy street or highway is very dangerous. If necessary, drive a short distance on the flat tire to get to a safe place. It is much better to ruin a tire or rim than to risk being hit.

Take the jack and tools from the tool area beneath the trunk mat. Remove the spare tire from the tire storage tray.

Loosen the wheel bolts while the car is on the ground, but leave them a little snug. Place the jack in the lifting point nearest the wheel being changed, lifting points are shown in Fig. 1 and Fig. 2). Use a board to provide a firm footing for the jack if the ground is soft. Raise the car only far enough so that the wheel is fully off the ground and then remove the wheel nuts and the wheel.

Install the spare wheel. Install the wheel nuts and tighten them by hand, then lower the car. With all wheels on the ground, fully tighten the nuts in a crisscross pattern. Torque the wheel nuts when installing the wheel. Check the inflation pressure of the spare tire.

Tightening torques

- Wheel to wheel hub 100 ± 10 Nm (74 ± 7 ft-lb)
-

Car Will Not Start

If the engine turns over slowly or not at all, especially on cold mornings, the battery may not be sufficiently charged. Jump-starting the battery from another car may help.

WARNING —

On cars with manual transmission, push starting (or tow starting) a car is not recommended by BMW.

NOTE —

Be sure to read the cautions under Jump Starting Car prior boosting a low battery. Failure to follow the cautions may result in damage to the electronic components in the car.

If the engine is turning over at normal speed with the starter motor, the battery and starter are fine. Check to make sure that there is fuel in the tank. Do not rely on the fuel gauge, it may be faulty. Instead, remove the gas filler cap and rock the car. If there is gas in the tank, you should hear a sloshing sound at the filler neck. If there is plenty of fuel in the tank, see **100 Engine-General** for in-depth diagnostics and troubleshooting procedures.

Jump Starting Car

Cars with discharged or dead batteries can be jump-started using the good battery from another car. When jump-starting the engine, always note the following warnings.

WARNING —

- Battery acid (electrolyte) can cause severe burns, and will damage the car and clothing. If electrolyte is spilled, wash the surface with large quantities of water. If it gets into eyes, flush them with water for several minutes and call a doctor.
- Batteries produce explosive and noxious gases. Keep sparks and flames away. Do not smoke near batteries.
- Do not jump-start the engine if you suspect that the battery is frozen. Trapped gas may explode. Allow the battery to thaw first.
- Do not quick-charge the battery (for boost starting) for longer than one minute, and do not exceed 15 volts at the battery with the boosting cables attached. Wait at least one minute before boosting the battery a second time.
- Some electrical system "comfort" features may not function correctly once battery power is restored. For example, the front window one-touch-up function may be disabled. Some electrical systems will need to be reinitialized. Consult the appropriate repair group for more specific information.

1. Place cars close together, but do not allow them to touch each other. Turn off the engine of the car with the good battery.
2. Connect one end of the positive (+) cable to the positive (+) post of the good battery. Remove the cover from the positive (B+) junction post in the engine compartment of the dead car and connect the other end of the positive (+) cable to the junction post. See Fig. 17.

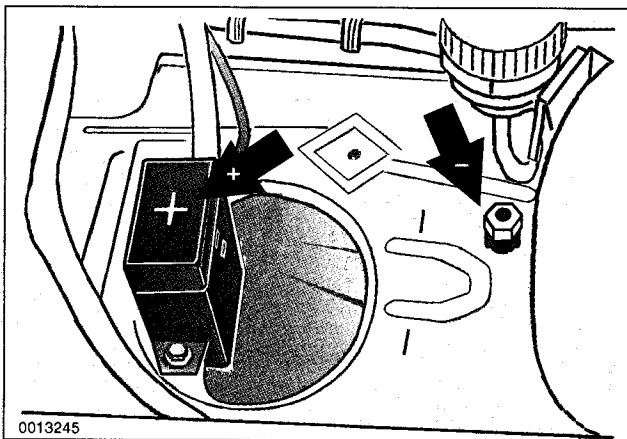

Fig. 17. Battery jump starting posts (arrows) behind right front strut tower. Lift cover to access positive post.

3. Connect one end of the negative (–) cable to the negative (–) battery post of the good battery. Connect opposite end of the negative cable (–) to the engine block of the car with the dead battery.
4. Start the car with the good battery and run the engine at about 2,000 rpm, then start the car with the dead battery.
5. With the engine at idle, switch on the headlights, blower motor and rear window defogger to avoid damaging the cars electrical system. Carefully disconnect the jumper cables, starting with the negative cable on the engine block. Turn all electrical consumers off.

NOTE —

The engine should be run for at least an hour to recharge the battery.

Overheating

If the temperature gauge needle goes into the red band on the gauge face, the coolant temperature is too high. Find a safe place to stop and turn the engine off. Open the hood and allow the engine to cool until the temperature gauge needle is at the lower third of the scale. Continuing to drive an overheated car can cause extensive engine damage.

WARNING —

Do not remove the coolant reservoir or radiator cap with the engine hot. Undoing either could spray hot coolant and cause burns or damage the engine.

CAUTION —

Do not add cold water or coolant to a hot engine. Engine damage could result from the sudden temperature change.

NOTE —

If the engine cannot be safely turned off, make sure the air conditioner is off and turn the heater to high. This will help cool the engine until a safe stopping place can be reached.

Overheating may be caused by low coolant level or a damaged engine drive belt. Visually check the coolant level and engine belts as described in **020 Maintenance Program**. If the coolant level is low, check the filler cap, hoses, clamps and radiator for signs of leakage. Check for leaks at the water pump on the front of the engine.

If no leaks are found, add coolant after the engine has cooled. The car can be driven, but have the cooling system thoroughly checked as soon as possible. If replacement coolant is not available, then plain water can be used, but the coolant should later be drained and refilled with the proper mixture of anti-freeze and water.

EMERGENCIES

If steam is coming from the engine compartment then there is most likely a burst coolant hose or a large leak in the cooling system. To find the leak, look for signs of coolant leakage on hoses, at hose connections, or on the radiator. Let the engine cool thoroughly, then add coolant or water to fill the system and start the engine. If a great deal of water or coolant flows out of the hole, then the car should not be driven until repairs are made. If there is slight seepage, then it may be possible to drive a short distance, adding coolant as needed.

Low Oil Pressure

If the red engine oil pressure warning light illuminates, immediately stop the car and turn off the engine. Have the vehicle flat-bedded or towed to an authorized service center and have the engine oil pressure checked.

NOTE —

Detailed information on checking the oil pressure is covered in 119 Lubrication System.

Brake Fluid Level

The brake fluid level warning light may be an indicator of brake fluid loss. Problems with the brake system should be checked and repaired immediately. See **340 Brakes** for more information.

Check Engine Warning Light

If the "CHECK ENGINE" warning light comes on or flashes, it indicates that an emissions-related fault has occurred. Faults such as a failed oxygen sensor or a faulty fuel injector can turn the light on, causing the exhaust or evaporative emissions to exceed a specified limit. The engine can be safely driven with the light on, although the emission systems should be checked as soon as possible. See **100 Engine—General** for more information on the Check Engine Light and the On-board diagnostic system.

Dim Lights

Headlights and instrument panel illumination that are dim or gradually getting dimmer generally indicate a problem with the battery or charging system. The battery charge indicator light may come on as the lights are dimming. In either case, the engine and accessories are running off of the battery alone, and will soon discharge it altogether.

If possible, do not stop the engine unless you have the capability to jump start it. There may not be enough power in the starting system to restart the engine. Instead, turn off as many electrical consumers as possible. This will reduce the current drain and will allow the car to be driven farther before you lose all battery power.

With the engine and ignition off, check for loose or corroded battery cables or wires at the battery or the alternator. Disconnecting, cleaning, and reinstalling corroded wires and connectors may solve the problem. Also check drive belt tension as described in **020 Maintenance Program**.

Towing

The cars covered by this manual should be towed with a tow truck using wheel lift or flat bed equipment. Do not tow the car on all four wheels except for very short distances to move it to a safe place.

A towing eye is provided in the luggage compartment tool kit. The towing eye can be screwed into the front or rear bumper. See Fig. 18 and Fig. 19.

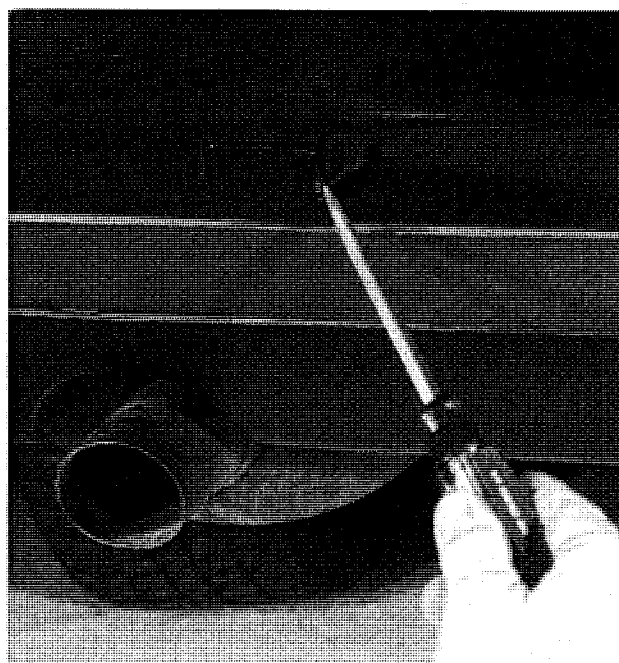

0013128

Fig. 18. Pry open rear tow lug access panel.

When towing the car from the front with the rear wheels on the ground, a maximum distance of 20 miles is acceptable. If the car needs to be towed further, have the rear wheels placed on dollies.

CAUTION —

- Do not tow with sling-type equipment. The front spoilers and bumper covers may sustain damage.
- Towing a BMW with an automatic transmission with the rear wheels on the ground can result in transmission damage due to lack of lubrication and should be avoided.

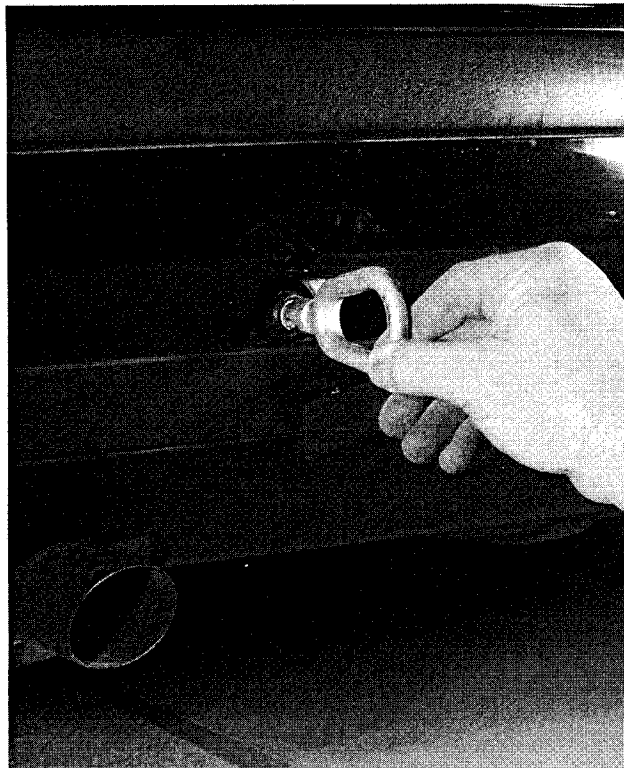

0013129

Fig. 19. Install rear tow lug into threaded hole.

If absolutely necessary, cars with automatic transmissions can be towed with the rear wheels on the ground, but the tow should not exceed 25 miles (40 km), at speeds at or below 30 mph (35 km/h). Be sure the transmission fluid has been topped off before starting the tow. Always tow the car with the transmission lever in "N" (neutral). If the tow must exceed 25 miles (40 km), add one quart of ATF to the transmission, or better yet, remove the driveshaft. Be sure to drain or pump out the added fluid once the tow has been completed.

NOTE —

- ATF draining and filling is covered in **240 Automatic Transmission**.
- Driveshaft removal is covered in **260 Driveshaft**.

EMERGENCIES

Spare Parts Kit

Carrying a basic set of spare parts can prevent a minor breakdown from turning into a major annoyance. Many of the following items won't allow you to do major repair work on the car, but they will help in the event of the failure of something that can disable the car or compromise its safety.

Spare Parts Kit - Basic Contents

- Drive belt (V-belt or poly-ribbed)
- Engine oil (one or two quarts)
- Engine coolant (1 gallon of premixed 50/50 anti-freeze and water)
- Fuse assortment (7.5A, 10A, 15A, 20A)
- Radiator hoses (upper and lower)

Spare Parts Kit - Additional Contents

- Exterior lighting bulbs (headlight, brakelight, turn signal, and taillight)
 - Wiper blades
 - Brake fluid (new unopened bottle, DOT 4 specification)
 - Main relay for DME system
-



020 Maintenance Program

GENERAL	020-2	UNDER-CAR MAINTENANCE	020-16
BMW Service Indicator	020-2	Fuel filter, replacing	020-16
Oil Service	020-2	Tires, checking inflation pressure	020-17
Inspection I and Inspection II	020-2	Tires, rotating	020-17
Resetting Service Indicator	020-3	Wheels, aligning	020-17
MAINTENANCE TABLES	020-3	Brake system, inspecting	020-17
FLUID AND LUBRICANT		Brake pad/rotor wear, checking	020-17
SPECIFICATIONS	020-8	Brake fluid, replacing	020-17
Manual Transmission Fluid	020-8	Parking brake, checking	020-17
Automatic Transmission Fluid	020-8	Exhaust system, inspecting	020-18
Final Drive Gear Oil	020-9	Manual Transmission Service	020-18
Brake Fluid	020-9	Manual transmission fluid,	
Engine Coolant (Anti-freeze)	020-9	checking and filling	020-18
Power Steering Fluid	020-9	Automatic Transmission Service	020-18
ENGINE OIL SERVICE	020-9	Front suspension and steering linkages,	
Engine oil, checking level	020-9	inspecting	020-18
Engine oil and filter, changing	020-9	Rear suspension, inspecting	020-18
ENGINE COMPARTMENT		Final drive oil level, checking	020-18
MAINTENANCE	020-10	Fuel tank and fuel lines, inspecting	020-19
Air filter, replacing	020-11	Clutch fluid, checking	020-19
Spark plugs, replacing	020-11	Drive axle joint boots, inspecting	020-19
Idle Speed	020-12	BODY AND INTERIOR	
Battery, checking and cleaning	020-12	MAINTENANCE	020-19
Battery, replacing	020-12	Windshield Wiper Blade Maintenance	020-19
Accelerator and Throttle Linkage	020-13	Body and hinges, lubricating	020-19
Engine Drive Belts	020-13	Seat Belts	020-20
V-belt, replacing		Exterior Washing	020-20
(4-cylinder engines built up to 1/94)	020-13	Waxing	020-20
Poly-ribbed belt, replacing		Polishing	020-20
(4-cylinder engines built from 1/94		Washing Chassis	020-20
and all 6-cylinder engines)	020-13	Special Cleaning	020-20
Cooling System Service	020-14	Interior Care	020-20
Power steering fluid, checking level	020-14	Leather Upholstery and Trim	020-20
Oxygen Sensors	020-15		
		TABLES	
		a. Oil Service	020-4
		b. Inspection I Service	020-5
		c. Inspection II Service	020-6
		d. Scheduled Maintenance-Time/Mileage Intervals ..	020-7
		e. Fluids and Lubricants	020-8

GENERAL

The information given in this repair group includes the routine checks and maintenance steps that are both required by BMW under the terms of the vehicle warranty protection and recommended by BMW to ensure long and reliable vehicle operation.

NOTE —

Aside from keeping your car in the best possible condition, proper maintenance plays a role in maintaining full protection under BMW's new-car warranty coverage. If in doubt about the terms and conditions of your car's warranty, an authorized BMW dealer should be able to explain them.

BMW has taken a unique approach to establishing maintenance intervals. BMW's Service Indicator System computes maintenance intervals based not only on elapsed mileage, but also on such inputs as engine speed, engine temperature, number of starts, and length of trips. At the appropriate time, the system indicates, through lights in the instrument cluster, when the next routine maintenance is due.

NOTE —

BMW is constantly updating their recommended maintenance procedures and requirements. The information contained here is as accurate as possible at the time of publication. If there is any doubt about what procedures apply to a specific model or model year, or what intervals should be followed, remember that an authorized BMW dealer has the latest information on factory-recommended maintenance.

BMW Service Indicator

The BMW Service Indicator notifies the driver when maintenance is required. The service indicator consists of multiple light emitting diodes (LEDs)—typically five green, one yellow, and one red—as well as **OIL SERVICE** and **INSPECTION** indicators.

When the ignition is turned on, the green LEDs come on. They go out when the engine is started. After the Service Indicator is reset, all green LEDs will be illuminated with the key on. As the car is driven in normal use, fewer and fewer green LEDs will be illuminated before start-up, indicating that the next maintenance interval is approaching.

When the car has accumulated sufficient use to require the next maintenance interval, the yellow LED will come on along with either the **OIL SERVICE** indicator or the **INSPECTION** indicator. These LEDs will stay on after the engine is started. If maintenance service is delayed, the red LED will also illuminate as a reminder that maintenance service is overdue.

An **OIL SERVICE** interval will always be followed by an **INSPECTION** interval, which will then be followed by an **OIL SERVICE** interval, and so on. See Fig. 1.

GENERAL

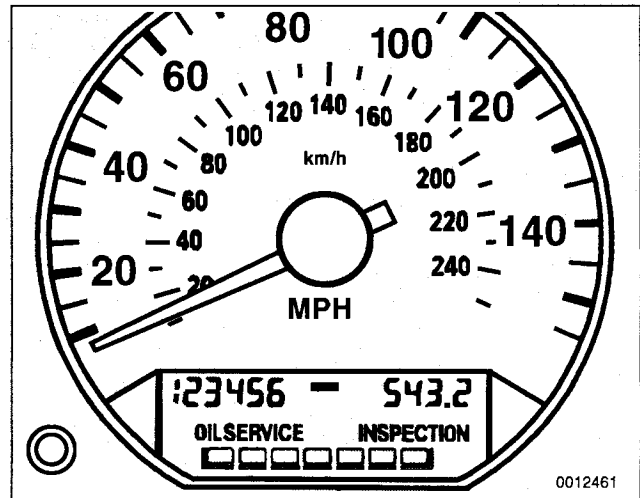

Fig. 1. Service indicator display in lower section of speedometer.

Oil Service

The Oil Service indicator signals the need for the most basic level of routine maintenance. BMW's required oil service specifies changing the engine lubricating oil and the engine oil filter after the engine has been warmed up. BMW-recommended additional maintenance for this service is listed in **Table a**.

NOTE —

- For reference, the BMW Oil Service requirements are approximately equivalent to the maintenance that other European manufacturers specify at intervals with a maximum of every 7,500 miles or 6 months.

CAUTION —

Be sure to follow the instructions for resetting the Oil Service indicator light. The Inspection indicator can be accidentally reset rendering its function inaccurate.

Inspection I and Inspection II

The Inspection indicator signals the need for more comprehensive maintenance and inspection. There are two sets of inspection requirements, Inspection I and Inspection II. These inspections alternate throughout a car's maintenance history. If the last inspection interval was Inspection I, the next inspection interval (following an Oil Service) will be Inspection II, the next after that will be Inspection I, and so on.

Inspection I tasks are listed in **Table b**. Inspection II includes most of the tasks from Inspection I with additional Inspection II tasks. A complete listing of Inspection II tasks are listed in **Table c**.

NOTE —

For reference, the BMW Inspection I and Inspection II requirements are approximately equivalent to the maintenance requirements that other European manufacturers specify. Inspection I is normally due at intervals with a maximum of 15,000 miles or 12 months. Inspection II is normally due at intervals with a maximum of 30,000 miles or 24 months.

Resetting Service Indicator

When the specified maintenance has been carried out, the service indicator memory should be reset.

The service indicator is reset using a special tool. The tool is plugged into the diagnostic connector in the engine compartment. See Fig. 2.

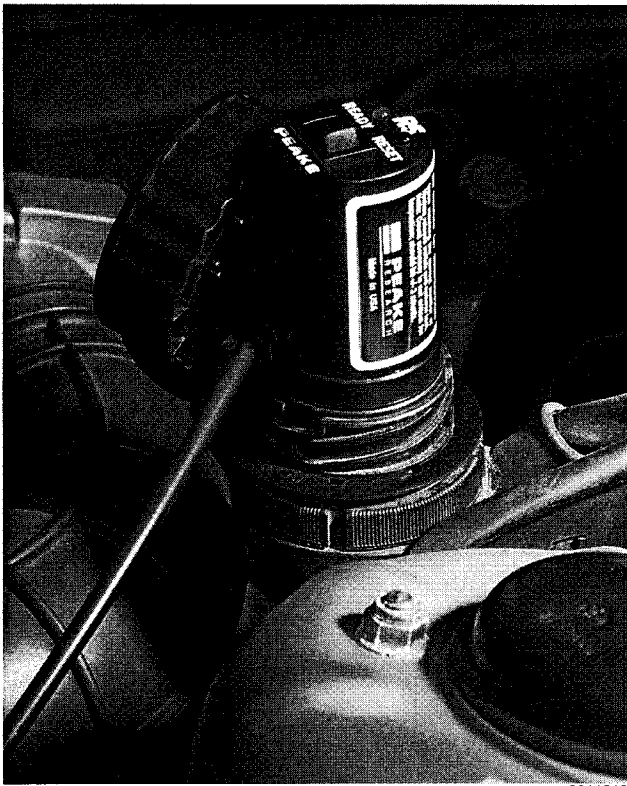

0011910

Fig. 2. Service indicator reset tool installed in diagnostic connector (aftermarket tool shown).

CAUTION —

Follow the manufacturer's directions when resetting the service indicator. If the reset procedures are done incorrectly, the reset tool or the electronic service indicator may be damaged.

Aftermarket reset tools can be purchased from one of the following manufacturers:

Assenmacher Specialty Tools
Boulder, CO 80301
(303) 530-2424

Peake Research, Automotive Products Division
P.O. Box 28776
San Jose, CA 95159
(408) 369-0406

MAINTENANCE TABLES

Table a, b, c, and d on the following pages list the routine maintenance tasks specified by BMW. The intervals for most of these tasks are determined by the Service Indicator. The maintenance intervals for a few additional items are based on either elapsed mileage or time. These intervals are indicated in separate tables.

Except where noted, the maintenance items listed apply to all models and model years covered by this manual. The columns on the right side of each table give quick-reference information about the job. The bold text references the repair groups where additional repair information can be found.

020-4 MAINTENANCE PROGRAM

Table a. Oil Service

Maintenance item	Tools required	New parts required	Warm engine required	Dealer service recommended
Engine compartment maintenance				
Change oil and oil filter		*	*	
Check fluid levels (coolant, steering, brake/clutch, ATF)		*	*	
Under car maintenance				
Check steering rack and steering linkages for leaks and excess play. Repair Group 320				
Inspect brake system. Check brake calipers, rotors, and brake pad thickness. Inspect for damaged hoses and lines, leaks or damage. Check hand brake, adjust cable if necessary. Repair Group 340				
Check and adjust tire pressures, including spare	*			
Body and interior maintenance				
Check operation of exterior and interior lights, including glove box light, engine compartment light, trunk light, instrument panel lights, horns, headlight flasher and dimmer switch. Check headlight and driving light aiming. 6 Electrical System				
Check function/condition of seat belts. Repair Group 720				
Check windshield washer fluid level and concentration, add as necessary. Check operation of washer system. Check condition of wiper blades. Repair Group 611		*		
Road Test				
Check braking performance, steering, heating and ventilation, manual or automatic transmission, and mirrors				
Service Interval Reset				
Reset service indicator using special reset tool.	*			

Table b. Inspection I Service

Maintenance item	Tools required	New parts required	Warm engine required	Dealer service recommended
Engine compartment maintenance				
Change oil and oil filter.	*	*	*	
Check brake/clutch fluid level		*		
Check battery acid level and correct as necessary. Repair Group 121				
Check engine coolant level and anti-freeze protection and add as necessary. Inspect for cooling system leaks. Repair Group 170		*		
Lubricate throttle linkage		*		
Under car maintenance				
Check transmission for external leaks.				
Check manual transmission oil level and add as necessary. Repair Group 230	*	*		
Check final drive lubricant and add as necessary.	*	*		
Check fuel tank, fuel lines, and all connections for leaks.				
Inspect exhaust system. Repair Group 180				
Check steering rack and steering linkages. Check power steering system for leaks. Check fluid level. Repair Group 320		*		*
Inspect brake system for damaged hoses and lines, leaks or damage. Remove calipers and check brake pad wear. Check brake rotors for scoring damage. Repair Group 340	*			
Check parking brake operation, adjust cable if necessary. Repair Group 340	*			
Inspect front and rear suspension, including wheel bearings, for play. Repair Group 320/330				*
Inspect wheels and tires, including spare, check tire pressure and condition				
Body and Interior Maintenance				
Lubricate door hinges and hood latch, hood hinges				
Check headlight and driving light aiming and adjust as necessary.	*			*
Check operation of headlights, parking lights, back-up lights, license plate lights, interior lights, glove box light, engine compartment light, trunk light, instrument panel lights, turn signals, emergency flashers, stop lights, horns, headlight flasher and dimmer switch				
Replace ventilation/A/C micro-filter. Check function of air conditioning. Repair Group 640	*			
Check function of seat belts. Repair Group 720				
Check tightness of mounting screws on airbag front crash sensors (Airbag I). Repair Group 721				
Check windshield washer fluid level and concentration, add as necessary. Check operation of washer system. Check condition of wiper blades. Repair Group 611		*		
Tighten nuts and bolts for door locks and striker plates				
Replace batteries for alarm/remote control in master key (where applicable).		*		
Road Test				
Check braking performance, steering, HVAC, manual or automatic transmission, and mirrors				
Service Interval Reset				
Reset service indicator using special reset tool.	*			

020-6 MAINTENANCE PROGRAM

Table c. Inspection II Service

Maintenance item	Tools required	New parts required	Warm engine required	Dealer service recommended
Engine compartment maintenance				
Inspect V-belt /Poly-ribbed drive condition. Check V-belt tension, if applicable.	*			
Lubricate throttle linkage.		*		
Replace air filter.	*	*		
Change oil and oil filter.	*	*	*	
Replace spark plugs. Repair Group 120	*	*		
Check brake/clutch fluid level.		*		
Check battery acid level and correct as necessary. Repair Group 121				
Check engine coolant level and anti-freeze protection and add as necessary. Inspect for cooling system leaks. Repair Group 170	*			
Under car maintenance				
Change automatic transmission fluid. Repair Group 240	*	*	*	
Change manual transmission oil. Repair Group 230	*	*	*	
Check clutch plate for wear. Repair Group 210	*			
Check drive axle boots for leaks. Repair Group 330				
Change final drive fluid (1995 and later models: change synthetic oil every 2nd Inspection II).	*		*	
Replace fuel filter.	*	*		
Check fuel tank, fuel lines, and all connections for leaks.				
Inspect exhaust system. Repair Group 180				
Check steering gear and steering linkages. Check power steering system for leaks. Check fluid level. Repair Group 320		*		*
Inspect brake system for damaged hoses and lines, leaks or damage. Remove calipers and check brake pad wear. Check brake rotors for scoring damage. Repair Group 340				
Check parking brake operation, adjust cable if necessary. Check thickness of parking brake linings. Repair Group 340		*		
Inspect front and rear suspension, including front and rear wheel bearings, for play. Repair Group 310/330				*
Inspect wheels and tires, including spare, check tire pressure and condition.				
Body and Interior Maintenance				
Lubricate door hinges and hood latch, hood hinges.		*		
Check headlight and driving light aiming and adjust as necessary.	*			*
Check operation of headlights, parking lights, back-up lights, license plate lights, interior lights, glove box light, engine compartment light, trunk light, instrument panel lights, turn signals, emergency flashers, stop lights, horns, headlight flasher and dimmer switch.				
Check active check control panel for faults (where applicable). 6 Electrical System				

Continued on next page

Table c. Inspection II Service (continued)

Maintenance item	Tools required	New parts required	Warm engine required	Dealer service recommended
Body and Interior Maintenance (cont.)				
Replace ventilation/A/C micro-filter. Check function of air conditioning. Repair Group 640	*	*		
Check function of seat belts. Repair Group 720				
Check windshield washer fluid level and concentration, add as necessary. Check operation of washer system. Check condition of wiper blades Repair Group 611		*		
Tighten nuts and bolts for door locks and striker plates.	*			
Replace batteries for alarm/remote control in master key (where applicable).		*		
Check ground connection (mounting screws) of SRS (airbag) front sensor to body, if applicable. Repair Group 721	*			*
Road Test				
Check braking performance, steering, HVAC, manual or automatic transmission, and mirrors				
Service Interval Reset				
Reset service indicator using special reset tool.	*			

Table d. Scheduled Maintenance—Time/Mileage Intervals

Maintenance item	every 12 months	every 24 months	every 36 months	every 50,000 miles	every 60,000 miles	every 100,000 miles	New parts required	Dealer service recommended
Replace oxygen sensor. Repair Group 180 1992-1994 1995- on				*		*	*	
Flush and replace brake fluid/clutch fluid. Repair Group 340		*					*	
Drain and flush cooling system and replace coolant. Repair Group 170 1992-1996 1997-1998			*				*	
Anti-corrosion warranty inspection.	*							*

FLUID AND LUBRICANT SPECIFICATIONS

The fluids and lubricants specified by BMW are listed in **Table e**. Shown below is engine oil viscosity (SAE grade) vs. operating temperature range for the BMW engines covered in this manual.

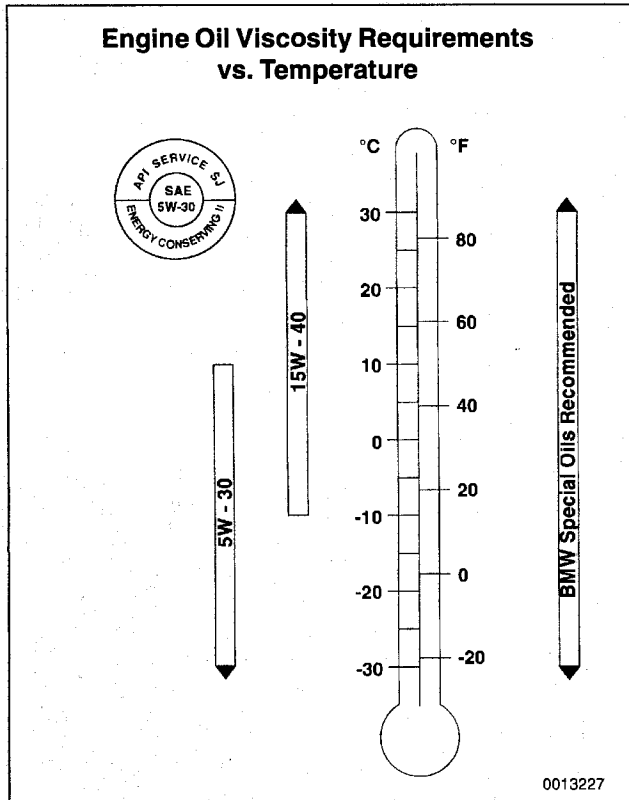

WARNING —
The use of fluids that do not meet BMW's specifications may impair performance and reliability, and may void warranty coverage.

Table e. Fluids and Lubricants

Fluid	Approximate capacity	Specification
Engine oil with filter change		
M42 engine	5.0 l (5.3 US qt.)	API service SH or SJ
M44 engine	5.0 l (5.3 US qt.)	
M50 engine	6.5 l (6.9 US qt.)	
M52 engine	6.5 l (6.9 US qt.)	
S50US engine	6.5 l (6.9 US qt.)	
S52US engine	6.0 l (6.3 US qt.)	
Manual transmission oil		
M42 engine	1.1 l (1.2 US qt.)	See 230 Manual Transmission for fluid specification information
M44 engine	1.1 l (1.2 US qt.)	
M50 engine	1.1 l (1.2 US qt.)	
M52 engine	1.2 l (1.3 US qt.)	
S50US engine	1.2 l (1.3 US qt.)	
S52US engine	1.2 l (1.3 US qt.)	

Continued

Table e. Fluids and Lubricants (continued)

Fluid	Approximate capacity	Specification
Automatic transmission fluid (ATF) (drain and fill) (additional fluid required when installing a dry torque converter)		
A4S 310R A4S 270R A5S 310Z	See 240 Automatic Transmission for fluid specification information	
Final drive (drain and fill) (Lifetime fluid; no fluid change required)		
4-cylinder 6-cylinder	1.1 l (1.2 US qt.) 1.7 l (1.8 US qt.)	BMW SAF-XO synthetic oil (ex. limited slip) BMW SAF-XLS synthetic oil (limited slip)
Power steering fluid		
All models	permanently sealed no drain plug	Dexron III® ATF
Brake fluid		
All models	—	SAE Dot 4
Engine coolant		
M42 engine M44 engine M50 engine M52 engine S50US engine S52US engine	6.5 l (6.9 US qt.) 6.5 l (6.9 US qt.) 10.5 l (11.1 US qt.) 10.5 l (11.1 US qt.) 10.75 l (11.4 qt.) 10.75 l (11.4 qt.)	50% BMW anti-freeze/ 50% water

CAUTION —
Multi-viscosity engine oils should not be used in the manual transmission. Use of such an oil could shorten the service life of the transmission.

Manual Transmission Fluid

The manual transmissions installed in the E36 models are normally filled with automatic transmission fluid (ATF), although alternative synthetic lubricants may have been used from the factory, depending on transmission type and model year. Consult **230 Manual Transmission** for additional information on identifying the type of fluid installed.

Automatic Transmission Fluid

The automatic transmissions installed in the E36 models are normally filled with Dexron III automatic transmission fluid (ATF), although alternative fluids have been installed from the factory, depending on transmission type and model year. Some transmission are filled with a special BMW "life-time" automatic transmission fluid, which does not require periodic fluid changes. Consult **240 Automatic Transmission** for additional fluid specification information.

NOTE —
The transmission lubricant type can be found on the "type-plate" on the side of the transmission. Consult an authorized BMW dealer for alternate fluid use and the most-up-to-date information regarding transmission operating fluids.