

# Beispielabbildungen

## Patentsammlung

### Puppenhäuser und Puppenmöbel



Abb. 2.



Abb. 1

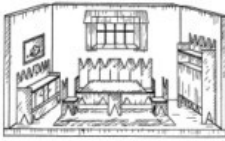

Abb. 2

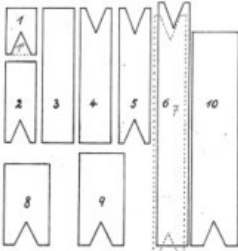
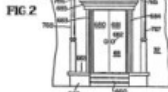

3003499 FIG. 2

FIG. 1

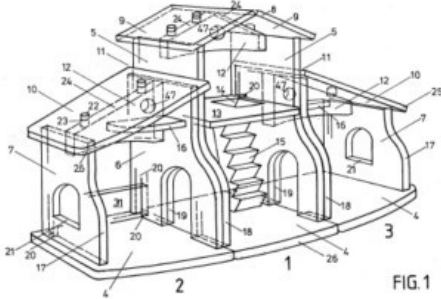
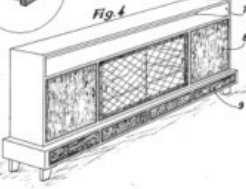
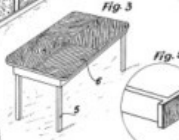
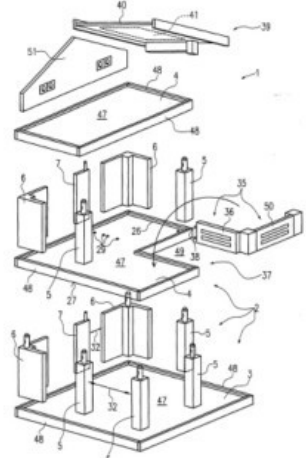
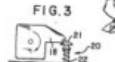
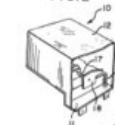

FIG. 1