

HYOSUNG

HYOSUNG

Aquila

SERVICE MANUAL

HYOSUNG MOTORS & MACHINERY INC.

Aquila

SERVICE MANUAL

99000-95210

FOREWORD

This manual contains an introductory description on *Aquila* HYOSUNG and procedures for its inspection/service and overhaul of its main components.

Other information considered as generally known is not included.

Read GENERAL INFORMATION section to familiarize yourself with outline of the vehicle and MAINTENANCE and other sections to use as a guide for proper inspection and service.

This manual will help you know the vehicle better so that you can assure your customers of your optimum and quick service.

❖ This manual has been prepared on the basis of the latest specification at the time of publication.

If modification has been made since then, difference may exist between the content of this manual and the actual vehicle.

❖ Illustrations in this manual are used to show the basic principles of operation and work procedures.

They may not represent the actual vehicle exactly in detail.

❖ This manual is intended for those who have enough knowledge and skills for servicing

HYOSUNG vehicles. Without such knowledge and skills, you should not attempt servicing by relying on this manual only.

Instead, please contact your nearby authorized HYOSUNG motorcycle dealer.

GROUP INDEX

GENERAL INFORMATION

1

PERIODIC MAINTENANCE

2

ENGINE

3

FUEL SYSTEM

4

ELECTRICAL SYSTEM

5

CHASSIS

6

SERVICING INFORMATION

7

HYOSUNG MOTORS & MACHINERY INC.

Overseas Technical Department

HOW TO USE THIS MANUAL

TO LOCATE WHAT YOU ARE LOOKING FOR:

1. The text of this manual is divided into sections.
2. As the title of these sections are listed on the previous page as GROUP INDEX, select the section where you are looking for.
3. Holding the manual as shown at the right will allow you to find the first page of the section easily.
4. On the first page of each section, its contents are listed. Find the item and page you need.

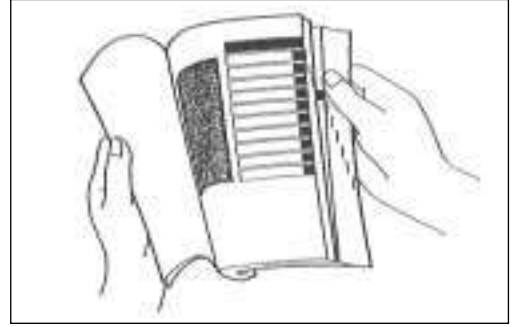





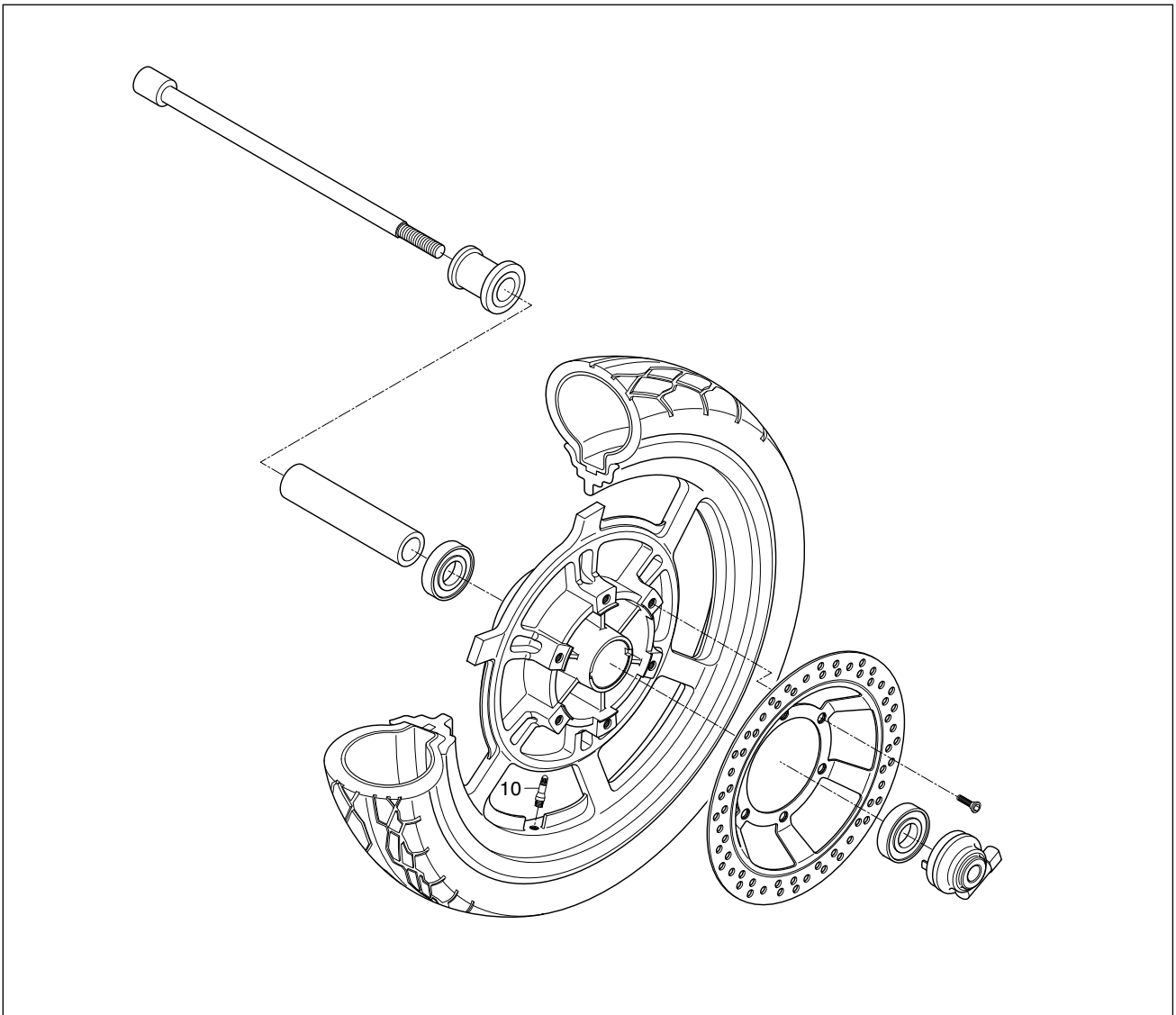







COMPONENT PARTS

Example: Front wheel



SYMBOL

Listed in the table below are the symbols indicating instructions and other information necessary for servicing and meaning associated with them respectively.

SYMBOL	DEFINITION	SYMBOL	DEFINITION
	Torque control required. Data beside it indicates specified torque.		Apply THREAD LOCK "1324".
	Apply oil. Use engine oil unless otherwise specified.		Apply or use brake fluid.
	Apply SUPER GREASE "A".		Measure in voltage range.
	Apply SUPER GREASE "C".		Measure in resistance range.
	Apply SILICONE GREASE.		Measure in current range.
	Apply MOLY PASTE.		Use special tool.
	Apply BOND "1215".		

GENERAL INFORMATION

CONTENTS

INFORMATION LABELS	1-1
GENERAL PRECAUTIONS	1-1
SERIAL NUMBER LOCATION	1-3
FUEL AND OIL RECOMMENDATIONS	1-4
BREAK-IN PROCEDURES	1-4
CYLINDER CLASSIFICATION	1-5
EXTERIOR ILLUSTRATION	1-6
SPECIFICATIONS	1-7

WARNING / CAUTION / NOTE

Please read this manual and follow its instructions carefully. To emphasize special information, the symbol and the words WARNING, CAUTION and NOTE have special meanings. Pay special attention to the messages highlighted by these signal words.

WARNING

Indicates a potential hazard that could result in death or injury.

CAUTION

Indicates a potential hazard that could result in vehicle damage.

NOTE:

Indicates special information to make maintenance easier or instructions cleaner.

Please note, however, that the warning and cautions contained in this manual cannot possibly cover all potential hazards relating to the servicing, or lack of servicing, of the motorcycle. In addition to the WARNING and CAUTION stated, you must use good judgement and basic mechanical safety principles. If you are unsure about how to perform a particular service operation, ask a more experienced mechanic for advice.

GENERAL PRECAUTIONS

WARNING

- ❖ Proper service and repair procedures are important for the safety of the service machanic and the safety and reliability of the vehicle.
- ❖ When 2 or more persons work together, pay attention to the safety of each other.
- ❖ When it is necessary to run the engine indoors, make sure that exhaust gas is forced outdoors.
- ❖ When working with toxic or flammable materials, make sure that the area you work in is well-ventilated and that you follow all off the material manufacturer' s instructions.
- ❖ Never use gasoline as a cleaning solvent.
- ❖ To avoid getting burned, do not touch the engine, engine oil or exhaust system during or for a while after engine operation.
- ❖ After servicing fuel, oil, exhaust or brake systems, check all lines and fittings related to the system for leaks.

⚠ CAUTION

- ❖ If parts replacement is necessary, replace the parts with HYOSUNG Genuine Parts or their equivalent.
- ❖ When removing parts that are to be reused, keep them arranged in an orderly manner so that they may be reinstalled in the proper order and orientation.
- ❖ Be sure to use special tools when instructed.
- ❖ Make sure that all parts used in reassembly are clean, and also lubricated when specified.
- ❖ When use of a certain type of lubricant, bond, or sealant is specified, be sure to use the specified type.
- ❖ When removing the battery, disconnect the negative cable first and then positive cable. When reconnecting the battery, connect the positive cable first and then negative cable, and replace the terminal cover on the positive terminal.
- ❖ When performing service to electrical parts, if the service procedures do not require use of battery power, disconnect the negative cable at the battery.
- ❖ Tighten cylinder head and case bolts and nuts, beginning with larger diameter and ending with smaller diameter, from inside to outside diagonally, to the specified tightening torque.
- ❖ Whenever you remove oil seals, gaskets, packing, O-rings, locking washers, cotter pins, circlips, and certain other parts as specified, be sure to replace them with new ones. Also, before installing these new parts, be sure to remove any left over material from the mating surfaces.
- ❖ Never reuse a circlip. When installing a new circlip, take care not to expand the end gap larger than required to slip the circlip over the shaft. After installing a circlip, always ensure that it is completely seated in its groove and securely fitted.
- ❖ Do not use self-locking nuts a few times over.
- ❖ Use a torque wrench to tighten fasteners to the torque values when specified. Wipe off grease or oil if a thread is smeared with them.
- ❖ After reassembly, check parts for tightness and operation.

- ❖ To protect environment, do not unlawfully dispose of used motor oil and other fluids: batteries, and tires.
- ❖ To protect Earth's natural resources, properly dispose of used vehicles and parts.

1-3 GENERAL INFORMATION

HYOSUNG *Aquila*



* Difference between photographs and actual motorcycles depends on the markets.

SERIAL NUMBER LOCATION

The frame serial number or V.I.N. (Vehicle Identification Number) is stamped on the steering head tube. The engine serial number is located on the left upside of crankcase assembly.

These numbers are required especially for registering the machine and ordering spare parts.

