

Contents

LIVING WITH YOUR CITROEN ZX

| | | |
|--------------------------------|------|------------|
| Introduction | Page | 0•4 |
| Safety First! | Page | 0•5 |
| General dimensions and weights | Page | 0•6 |

MOT Test Checks

| | | |
|--|------|-------------|
| Checks carried out from the driver's seat | Page | 0•7 |
| Checks carried out with the vehicle on the ground | Page | 0•8 |
| Checks carried out with the vehicle raised | Page | 0•9 |
| Checks carried out on your vehicle's exhaust emission system | Page | 0•10 |

Roadside Repairs

| | | |
|---|------|-------------|
| Buying spare parts and vehicle identification numbers | Page | 0•11 |
| Jacking, towing and wheel changing | Page | 0•12 |
| Booster battery (jump) starting | Page | 0•14 |
| Identifying leaks | Page | 0•15 |
| Radio/cassette unit anti-theft system - precaution | Page | 0•15 |
| Conversion factors | Page | 0•16 |

Routine Maintenance

| | | |
|-----------------------------------|------|-------------|
| Routine maintenance and servicing | Page | 1•1 |
| Lubricants, fluids and capacities | Page | 1•2 |
| Maintenance schedule | Page | 1•3 |
| Weekly checks | Page | 1•8 |
| Every 6000 miles or 6 months | Page | 1•11 |
| Every 12 000 miles or 12 months | Page | 1•14 |
| Every 18 000 miles or 18 months | Page | 1•20 |
| Every 24 000 miles or 2 years | Page | 1•22 |
| Every 40 000 miles or 2 years | Page | 1•23 |
| Every 48 000 miles | Page | 1•26 |
| Every 72 000 miles | Page | 1•26 |

Contents

REPAIRS & OVERHAUL

Engine and Associated Systems

| | | |
|---|------|-------------|
| TU series engine in-car repair procedures | Page | 2A•1 |
| XU series engine in-car repair procedures | Page | 2B•1 |
| Engine removal and general engine overhaul procedures | Page | 2C•1 |
| Cooling, heating and ventilation systems | Page | 3•1 |
| Fuel and exhaust systems - carburettor models | Page | 4A•1 |
| Fuel and exhaust systems - single-point fuel injection models | Page | 4B•1 |
| Fuel and exhaust systems - multi-point fuel injection models | Page | 4C•1 |
| Emission control systems | Page | 4D•1 |
| Engine electrical systems | Page | 5•1 |

Transmission

| | | |
|------------------------|------|-------------|
| Clutch | Page | 6•1 |
| Manual transmission | Page | 7A•1 |
| Automatic transmission | Page | 7B•1 |
| Driveshafts | Page | 8•1 |

Brakes

| | | |
|----------------|------|------------|
| Braking system | Page | 9•1 |
|----------------|------|------------|

Suspension

| | | |
|-------------------------|------|-------------|
| Suspension and steering | Page | 10•1 |
|-------------------------|------|-------------|

Body Equipment

| | | |
|-----------------------|------|-------------|
| Bodywork and fittings | Page | 11•1 |
|-----------------------|------|-------------|

Electrical

| | | |
|-------------------------|------|--------------|
| Body electrical systems | Page | 12•1 |
| Wiring Diagrams | Page | 12•19 |

REFERENCE

| | | |
|------------------------------|------|---------------|
| Tools and Working Facilities | Page | REF• 1 |
| General Repair Procedures | Page | REF• 4 |
| Fault Finding | Page | REF• 5 |
| Glossary of Technical Terms | Page | REF•12 |

Index

| | |
|------|---------------|
| Page | REF•16 |
|------|---------------|

Introduction to the Citroen ZX

The Citroen ZX range was introduced to the UK in June 1991. Originally, the ZX was available with a choice of 1.1 litre (1124 cc), 1.4 litre (1360 cc), 1.6 litre (1580 cc) or 1.9 litre (1905 cc) engines. Not all engine sizes, however, were available in all markets (the 1.1 litre version was not available in the UK).

At first, only five-door Hatchback models

were available. All models have a five-speed manual transmission as standard; a four-speed automatic transmission was offered as an option on 1.6 and 1.9 litre models.

All engines are derived from the well-proven TU series (1124 cc and 1360 cc) and XU series (1580 cc and 1905 cc models) engines, which have appeared in many

Citroen and Peugeot vehicles. The engines are of four-cylinder overhead camshaft design, mounted transversely and inclined to the rear, with the transmission mounted on the left-hand side.

In late 1992, a three-door Hatchback variant was introduced. At the same time, three new "sports" models were also introduced, all of which were equipped with new engines. These new models were the 1.8 litre (1761 cc) Furio, the 2.0 litre (1998 cc 8-valve) Volcane, and the 2.0 litre (1998 cc 16-valve) 16-valve model. All of these new models are available in three-door form only. All three of the new engines are again derived from the XU series engine.

On all models, fully-independent front suspension is fitted, with the components attached to a subframe assembly. The rear suspension is semi-independent, with torsion bars and trailing arms.

All models in the range are comprehensively-equipped, and anti-lock braking (ABS) and air conditioning systems are available as options on certain models (ABS is standard on the 2.0 litre 16-valve).

Provided that regular servicing is carried out in accordance with the manufacturer's recommendations, the Citroen ZX should prove reliable and very economical. The engine compartment is well-designed, and most of the items requiring frequent attention are easily accessible.

Acknowledgements

Thanks are due to Champion Spark Plug, who supplied the illustrations showing spark plug conditions. Certain other illustrations are the copyright of Citroen Cars Ltd, and are used with their permission. Thanks are also due to Sykes-Pickavant Limited, who provided some of the workshop tools, and to all those people at Sparkford who helped in the production of this manual.

Project vehicles

Various project vehicles were used in the preparation of this manual, and appear in many of the photographic sequences. These include a 1360 cc, 1580 cc, 1761 cc, 1905 cc, 1998 cc 8-valve and a 1998 cc 16-valve

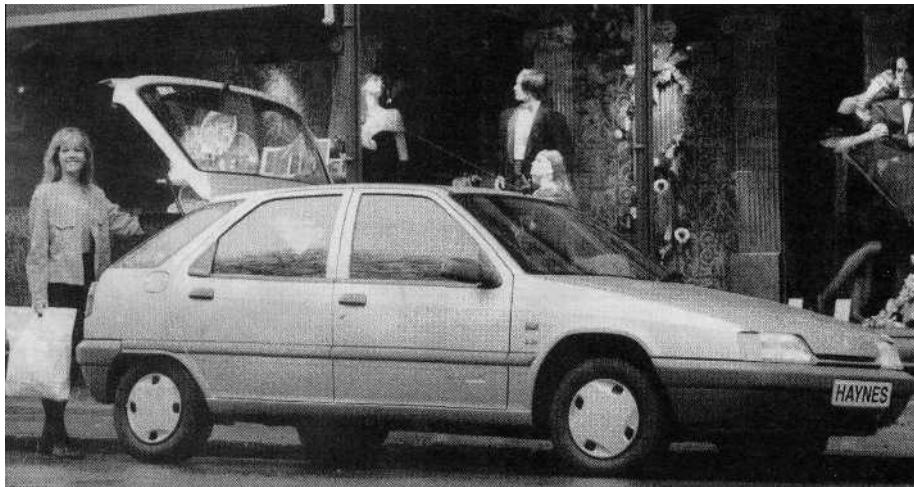

Citroen ZX 1.4 Reflex Plus 5-door



Citroen ZX 2.0 16-valve

Working on your car can be dangerous. This page shows just some of the potential risks and hazards, with the aim of creating a safety-conscious attitude.

General hazards

Scalding

- Don't remove the radiator or expansion tank cap while the engine is hot.
- Engine oil, automatic transmission fluid or power steering fluid may also be dangerously hot if the engine has recently been running.

Burning

- Beware of burns from the exhaust system and from any part of the engine. Brake discs and drums can also be extremely hot immediately after use.

Crushing

- When working under or near a raised vehicle, always supplement the jack with axle stands, or use drive-on ramps. **Never venture under a car which is only supported by a jack.**

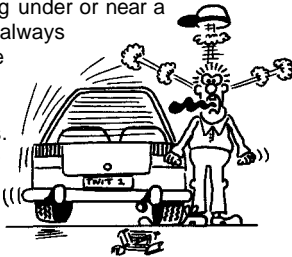

- Take care if loosening or tightening high-torque nuts when the vehicle is on stands. Initial loosening and final tightening should be done with the wheels on the ground.

Fire

- Fuel is highly flammable; fuel vapour is explosive.
- Don't let fuel spill onto a hot engine.
- Do not smoke or allow naked lights (including pilot lights) anywhere near a vehicle being worked on. Also beware of creating sparks (electrically or by use of tools).
- Fuel vapour is heavier than air, so don't work on the fuel system with the vehicle over an inspection pit.
- Another cause of fire is an electrical overload or short-circuit. Take care when repairing or modifying the vehicle wiring.
- Keep a fire extinguisher handy, of a type suitable for use on fuel and electrical fires.

Electric shock

- Ignition HT voltage can be dangerous, especially to people with heart problems or a pacemaker. Don't work on or near the ignition system with the engine running or the ignition switched on.

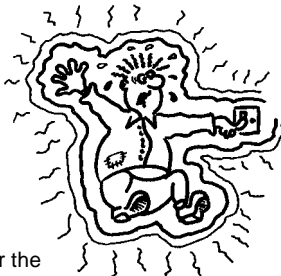

- Mains voltage is also dangerous. Make sure that any mains-operated equipment is correctly earthed. Mains power points should be protected by a residual current device (RCD) circuit breaker.

Fume or gas intoxication

- Exhaust fumes are poisonous; they often contain carbon monoxide, which is rapidly fatal if inhaled. Never run the engine in a confined space such as a garage with the doors shut.
- Fuel vapour is also poisonous, as are the vapours from some cleaning solvents and paint thinners.

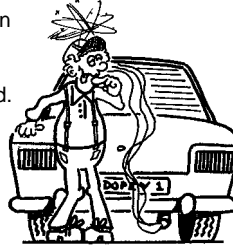

Poisonous or irritant substances

- Avoid skin contact with battery acid and with any fuel, fluid or lubricant, especially antifreeze, brake hydraulic fluid and Diesel fuel. Don't syphon them by mouth. If such a substance is swallowed or gets into the eyes, seek medical advice.
- Prolonged contact with used engine oil can cause skin cancer. Wear gloves or use a barrier cream if necessary. Change out of oil-soaked clothes and do not keep oily rags in your pocket.
- Air conditioning refrigerant forms a poisonous gas if exposed to a naked flame (including a cigarette). It can also cause skin burns on contact.

Asbestos

- Asbestos dust can cause cancer if inhaled or swallowed. Asbestos may be found in gaskets and in brake and clutch linings. When dealing with such components it is safest to assume that they contain asbestos.

Special hazards

Hydrofluoric acid

- This extremely corrosive acid is formed when certain types of synthetic rubber, found in some O-rings, oil seals, fuel hoses etc. are exposed to temperatures above 400°C. The rubber changes into a charred or sticky substance containing the acid. *Once formed, the acid remains dangerous for years. If it gets onto the skin, it may be necessary to amputate the limb concerned.*
- When dealing with a vehicle which has suffered a fire, or with components salvaged from such a vehicle, wear protective gloves and discard them after use.

The battery

- Batteries contain sulphuric acid, which attacks clothing, eyes and skin. Take care when topping-up or carrying the battery.
- The hydrogen gas given off by the battery is highly explosive. Never cause a spark or allow a naked light nearby. Be careful when connecting and disconnecting battery chargers or jump leads.

Air bags

- Air bags can cause injury if they go off accidentally. Take care when removing the steering wheel and/or facia. Special storage instructions may apply.

Diesel injection equipment

- Diesel injection pumps supply fuel at very high pressure. Take care when working on the fuel injectors and fuel pipes.



Warning: Never expose the hands, face or any other part of the body to injector spray; the fuel can penetrate the skin with potentially fatal results.

Remember...

DO

- Do use eye protection when using power tools, and when working under the vehicle
- Do wear gloves or use barrier cream to protect your hands when necessary.
- Do get someone to check periodically that all is well when working alone on the vehicle,
- Do keep loose clothing and long hair well out of the way of moving mechanical parts.
- Do remove rings, wristwatch etc. before working on the vehicle - especially the electrical system.
- Do ensure that any lifting or lacking equipment has a safe working load rating adequate for the job.

DON'T

- Don't attempt to lift a heavy component which may be beyond your capability - get assistance.
- Don't rush to finish a job, or take unverified short cuts.
- Don't use ill-fitting tools which may slip and cause injury.
- Don't leave tools or parts lying around where someone can trip over them. Mop up oil and fuel spills at once.
- Don't allow children or pets to play in or near a vehicle being worked on.

Dimensions

Overall length:

| | |
|-----------------------------------|----------|
| Volcane, Funo and 16-valve models | .4090 mm |
| All other models | .4070 mm |

Overall width (excluding mirrors):

| | |
|-----------------------------|----------|
| Volcane and 16-valve models | .1710 mm |
| Funo models | .1690 mm |
| All other models | .1700 mm |

Overall height

| | |
|-----------------------------------|----------|
| Volcane, Funo and 16-valve models | .1400 mm |
| All other models | .1390 mm |

| | |
|------------------------|----------|
| Wheelbase - all models | .2540 mm |
|------------------------|----------|

Front and rear track:

| | |
|----------------------------|----------|
| Reflex and Avantage models | .1410 mm |
| All other models | .1420 mm |

Turning circle:

| | |
|-------------------------------------|---------|
| Models with manual steering | .10.5 m |
| Models with power-assisted steering | .10.7 m |

Weights

Kerb weights (approximate):

| | |
|-----------------------------|----------|
| 1124 cc and 1360 cc models: | |
| Three-door models | .935 kg |
| Five-door models | .945 kg |
| 1580 cc models: | |
| Three-door models | .995 kg |
| Five-door models | .1015 kg |
| 1761 cc models: | |
| Three-door models | .1008 kg |
| Five-door models | .1024 kg |
| 1905 cc models: | |
| Three-door models | .1055 kg |
| Five-door models | .1085 kg |
| 1998 cc 8-valve models: | |
| Three-door models | .1060 kg |
| Five-door models | .1091 kg |
| 1998 cc 16-valve models | |
| | .1150 kg |

Maximum gross vehicle weight:

| | |
|----------------------------|----------|
| 1124 cc and 1360 cc models | .1490 kg |
| 1580 cc models | .1540 kg |
| 1761 cc models | .1550 kg |
| 1905 cc models | .1570 kg |
| 1998 cc 8-valve models | .1600 kg |
| 1998 cc 16-valve models | .1630 kg |

| | |
|------------------------|--------|
| Maximum roof rack load | .75 kg |
|------------------------|--------|

| | |
|----------------------------|--------|
| Maximum towing nose weight | .70 kg |
|----------------------------|--------|

Maximum towing weight:

Braked trailer:

| | |
|----------------------------|----------|
| 1905 cc and 1998 cc models | .1100 kg |
| All other models | .1000 kg |

Unbraked trailer:

| | |
|----------------------------|---------|
| 1124 cc and 1360 cc models | .470 kg |
| 1580 cc models | .490 kg |
| 1761 cc models | .500 kg |
| 1905 cc models | .510 kg |
| 1998 cc models | .530 kg |

This is a guide to getting your vehicle through the MOT test. Obviously it will not be possible to examine the vehicle to the same standard as the professional MOT tester. However, working through the following checks will enable you to identify any problem areas before submitting the vehicle for the test.

Where a testable component is in borderline condition, the tester has discretion in deciding whether to pass or fail it. The basis of such discretion is whether the tester would be happy for a close relative or friend to use the vehicle with the component in that condition. If the vehicle presented is clean and evidently well cared for, the tester may be more inclined to pass a borderline component than if the vehicle is scruffy and apparently neglected.

It has only been possible to summarise the test requirements here, based on the regulations in force at the time of printing. Test standards are becoming increasingly stringent, although there are some exemptions for older vehicles. For full details obtain a copy of the Haynes publication *Pass the MOT!* (available from stockists of Haynes manuals).

An assistant will be needed to help carry out some of these checks.



The checks have been sub-divided into four categories, as follows:

1 Checks carried out FROM THE DRIVER'S SEAT

2 Checks carried out WITH THE VEHICLE ON THE GROUND

3 Checks carried out WITH THE VEHICLE RAISED AND THE WHEELS FREE TO TURN

4 Checks carried out on YOUR VEHICLE'S EXHAUST EMISSION SYSTEM

1 Checks carried out FROM THE DRIVER'S SEAT

Handbrake

- Test the operation of the handbrake. Excessive travel (too many clicks) indicates incorrect brake or cable adjustment.
- Check that the handbrake cannot be released by tapping the lever sideways. Check the security of the lever mountings.

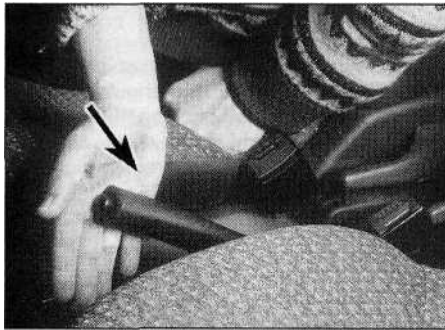

Footbrake

- Depress the brake pedal and check that it does not creep down to the floor, indicating a master cylinder fault. Release the pedal, wait a few seconds, then depress it again. If the pedal travels nearly to the floor before firm resistance is felt, brake adjustment or repair is necessary. If the pedal feels spongy, there is air in the hydraulic system which must be removed by bleeding.

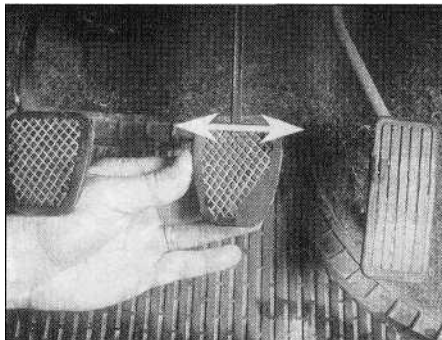

- Check that the brake pedal is secure and in good condition. Check also for signs of fluid leaks on the pedal, floor or carpets, which would indicate failed seals in the brake master cylinder.
- Check the servo unit (when applicable) by operating the brake pedal several times, then keeping the pedal depressed and starting the engine. As the engine starts, the pedal will move down slightly. If not, the vacuum hose or the servo itself may be faulty.

Steering wheel and column

- Examine the steering wheel for fractures or looseness of the hub, spokes or rim.
- Move the steering wheel from side to side and then up and down. Check that the steering wheel is not loose on the column, indicating wear OK a loose retaining nut. Continue moving the steering wheel as before, but also turn it slightly from left to right.
- Check that the steering wheel is not loose on the column, and that there is no abnormal

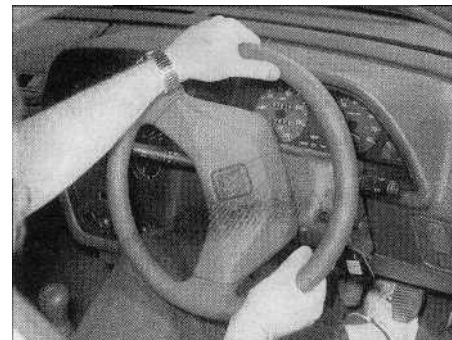

movement of the steering wheel, indicating wear in the column support bearings or couplings.

Windscreen and mirrors

- The windscreen must be free of cracks or other significant damage within the driver's field of view. (Small stone chips are acceptable.) Rear view mirrors must be secure, intact, and capable of being adjusted.

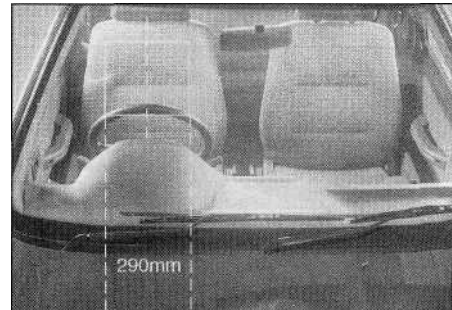

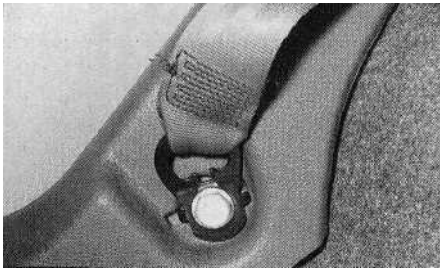

Seat belts and seats

Note: The following checks are applicable to all seat belts, front and rear.

- Examine the webbing of all the belts (including rear belts if fitted) for cuts, serious fraying or deterioration. Fasten and unfasten each belt to check the buckles. If applicable, check the retracting mechanism. Check the security of all seat belt mountings accessible from inside the vehicle.
- The front seats themselves must be securely attached and the backrests must lock in the upright position.

Doors

- Both front doors must be able to be opened and closed from outside and inside, and must latch securely when closed.

2

Checks carried out
**WITH THE VEHICLE ON THE
GROUND**

Vehicle identification

- Number plates must be in good condition, secure and legible, with letters and numbers correctly spaced - spacing at (A) should be twice that at (B).



- The VIN plate (A) and homologation plate (B) must be legible.

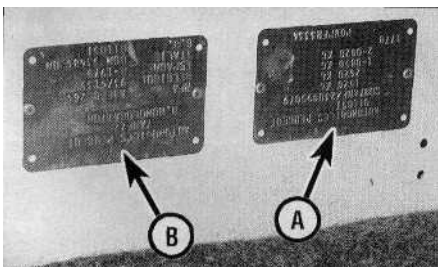

Electrical equipment

- Switch on the ignition and check the operation of the horn.
- Check the windscreen washers and wipers, examining the wiper blades; renew damaged or perished blades. Also check the operation of the stop-lights.

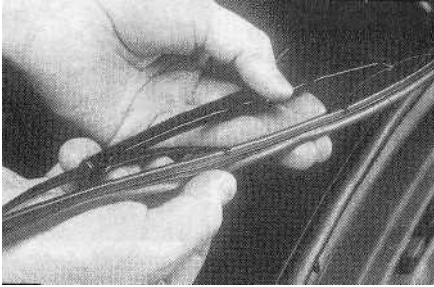

- Check the operation of the sidelights and number plate lights. The lenses and reflectors must be secure, clean and undamaged.
- Check the operation and alignment of the headlights. The headlight reflectors must not be tarnished and the lenses must be undamaged.
- Switch on the ignition and check the operation of the direction indicators (including the instrument panel tell-tale) and the hazard warning lights. Operation of the sidelights and stop-lights must not affect the indicators - if it does, the cause is usually a bad earth at the rear light cluster.
- Check the operation of the rear foglight(s), including the warning light on the instrument panel or in the switch.

Footbrake

- Examine the master cylinder, brake pipes and servo unit for leaks, loose mountings, corrosion or other damage.

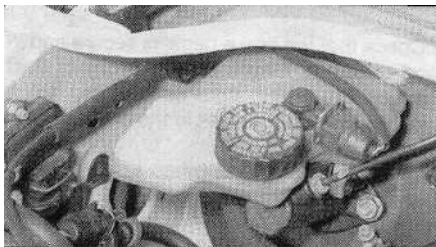

- The fluid reservoir must be secure and the fluid level must be between the upper (A) and lower (B) markings.

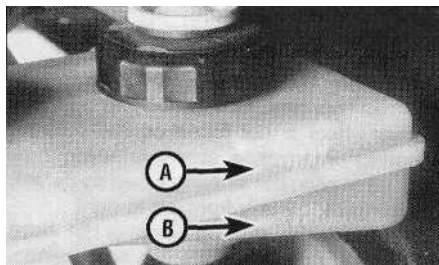

- Inspect both front brake flexible hoses for cracks or deterioration of the rubber. Turn the steering from lock to lock, and ensure that the hoses do not contact the wheel, tyre, or any part of the steering or suspension mechanism. With the brake pedal firmly depressed, check the hoses for bulges or leaks under pressure.

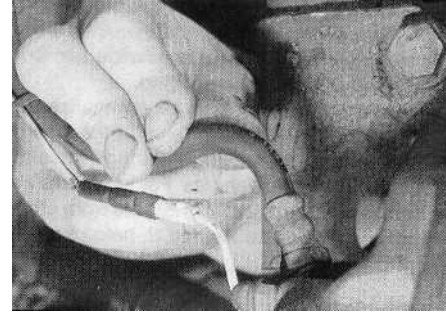

Steering and suspension

- Have your assistant turn the steering wheel from side to side slightly, up to the point where the steering gear just begins to transmit this movement to the roadwheels. Check for excessive free play between the steering wheel and the steering gear, indicating wear or insecurity of the steering column joints, the column-to-steering gear coupling, or the steering gear itself.
- Have your assistant turn the steering wheel more vigorously in each direction, so that the roadwheels just begin to turn. As this is done, examine all the steering joints, linkages, fittings and attachments. Renew any component that shows signs of wear or damage. On vehicles with power steering, check the security and condition of the steering pump, drivebelt and hoses.
- Check that the vehicle is standing level, and at approximately the correct ride height.

Shock absorbers

- Depress each corner of the vehicle in turn, then release it. The vehicle should rise and then settle in its normal position. If the vehicle continues to rise and fall, the shock absorber is defective. A shock absorber which has seized will also cause the vehicle to fail.



Exhaust system

- Start the engine. With your assistant holding a rag over the tailpipe, check the entire system for leaks. Repair or renew leaking sections.

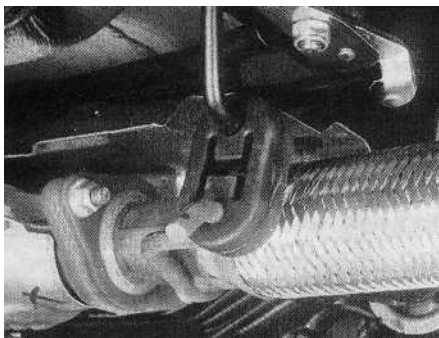

3 Checks carried out WITH THE VEHICLE RAISED AND THE WHEELS FREE TO TURN

Jack up the front and rear of the vehicle, and securely support it on axle stands. Position the stands clear of the suspension assemblies. Ensure that the wheels are clear of the ground and that the steering can be turned from lock to lock.

Steering mechanism

- Have your assistant turn the steering from lock to lock. Check that the steering turns smoothly, and that no part of the steering mechanism, including a wheel or tyre, fouls any brake hose or pipe or any part of the body structure.
- Examine the steering rack rubber gaiters for damage or insecurity of the retaining clips. If power steering is fitted, check for signs of damage or leakage of the fluid hoses, pipes or connections. Also check for excessive stiffness or binding of the steering, a missing split pin or locking device, or severe corrosion of the body structure within 30 cm of any steering component attachment point.



Front and rear suspension and wheel bearings

- Starting at the front right-hand side, grasp the roadwheel at the 3 o'clock and 9 o'clock positions and shake it vigorously. Check for free play or insecurity at the wheel bearings, suspension balljoints, or suspension mountings, pivots and attachments.
- Now grasp the wheel at the 12 o'clock and 6 o'clock positions and repeat the previous inspection. Spin the wheel, and check for roughness or tightness of the front wheel bearing.

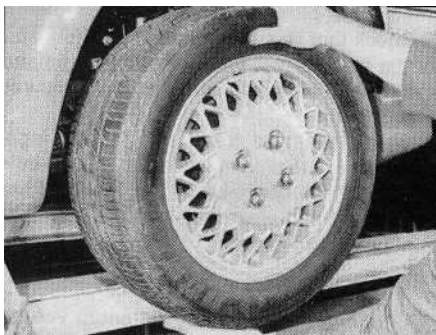

- If excess free play is suspected at a component pivot point, this can be confirmed by using a large screwdriver or similar tool and levering between the mounting and the component attachment. This will confirm whether the wear is in the pivot bush, its retaining bolt, or in the mounting itself (the bolt holes can often become elongated).

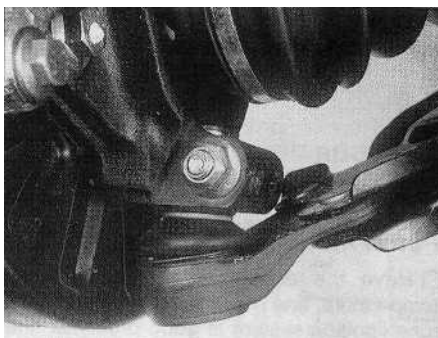

- Carry out all the above checks at the other front wheel, and then at both rear wheels.

Springs and shock absorbers

- Examine the suspension struts (when applicable) for serious fluid leakage, corrosion, or damage to the casing. Also check the security of the mounting points.
- If coil springs are fitted, check that the spring ends locate in their seats, and that the spring is not corroded, cracked or broken.
- If leaf springs are fitted, check that all leaves are intact, that the axle is securely attached to each spring, and that there is no deterioration of the spring eye mountings, bushes, and shackles.

- The same general checks apply to vehicles fitted with other suspension types, such as torsion bars, hydraulic displacer units, etc. Ensure that all mountings and attachments are secure, that there are no signs of excessive wear, corrosion or damage, and (on hydraulic types) that there are no fluid leaks or damaged pipes.

- Inspect the shock absorbers for signs of serious fluid leakage. Check for wear of the mounting bushes or attachments, or damage to the body of the unit.

Driveshafts (fwd vehicles only)

- Rotate each front wheel in turn and inspect the constant velocity joint gaiters for splits or damage. Also check that each driveshaft is straight and undamaged.

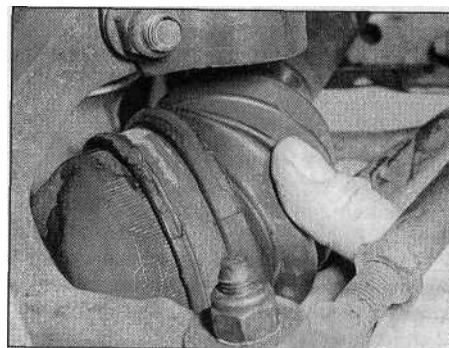

Braking system

- If possible without dismantling, check brake pad wear and disc condition. Ensure that the friction lining material has not worn excessively, (A) and that the discs are not fractured, pitted, scored or badly worn (B).

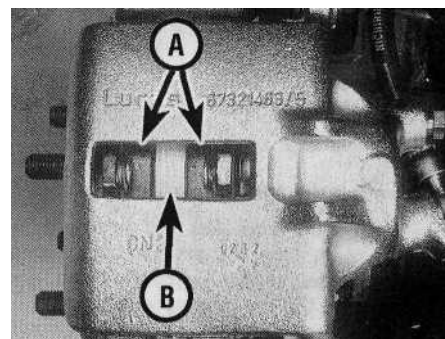

- Examine all the rigid brake pipes underneath the vehicle, and the flexible hose(s) at the rear. Look for corrosion, chafing or insecurity of the pipes, and for signs of bulging under pressure, chafing, splits or deterioration of the flexible hoses.
- Look for signs of fluid leaks at the brake calipers or on the brake backplates. Repair or renew leaking components.
- Slowly spin each wheel, while your assistant depresses and releases the footbrake. Ensure that each brake is operating and does not bind when the pedal is released.

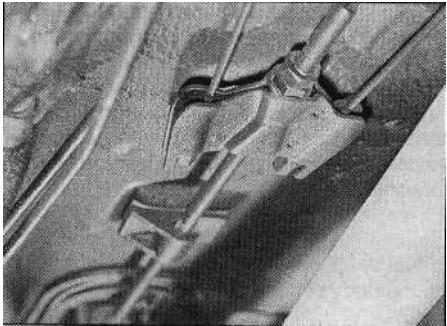

- Examine the handbrake mechanism, checking for frayed or broken cables, excessive corrosion, or wear or insecurity of the linkage. Check that the mechanism works on each relevant wheel, and releases fully, without binding.
- It is not possible to test brake efficiency without special equipment, but a road test can be carried out later to check that the vehicle pulls up in a straight line.

Fuel and exhaust systems

- Inspect the fuel tank (including the filler cap), fuel pipes, hoses and unions. All components must be secure and free from leaks.
- Examine the exhaust system over its entire length, checking for any damaged, broken or missing mountings, security of the retaining clamps and rust or corrosion.

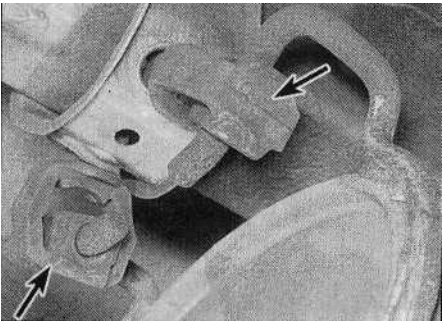

Wheels and tyres

- Examine the sidewalls and tread area of each tyre in turn. Check for cuts, tears, lumps, bulges, separation of the tread, and exposure of the ply or cord due to wear or damage. Check that the tyre bead is correctly seated on the wheel rim, that the valve is

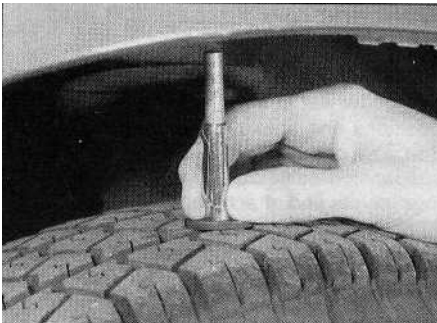

sound and properly seated, and that the wheel is not distorted or damaged.

- Check that the tyres are of the correct size for the vehicle, that they are of the same size and type on each axle, and that the pressures are correct.
- Check the tyre tread depth. The legal minimum at the time of writing is 1.6 mm over at least three-quarters of the tread width. Abnormal tread wear may indicate incorrect front wheel alignment.

Body corrosion

Check the condition of the entire vehicle structure for signs of corrosion in load-bearing areas. (These include chassis box sections, side sills, cross-members, pillars, and all suspension, steering, braking system and seat belt mountings and anchorages.) Any corrosion which has seriously reduced the thickness of a load-bearing area is likely to cause the vehicle to fail. In this case professional repairs are likely to be needed.

- Damage or corrosion which causes sharp or otherwise dangerous edges to be exposed will also cause the vehicle to fail.

4

Checks carried out on
**YOUR VEHICLE'S EXHAUST
EMISSION SYSTEM**

Petrol models

- Have the engine at normal operating temperature, and make sure that it is in good tune (ignition system in good order, air filter element clean, etc).
- Before any measurements are carried out, raise the engine speed to around 2500 rpm, and hold it at this speed for 20 seconds. Allow the engine speed to return to idle, and

watch for smoke emissions from the exhaust tailpipe. If the idle speed is obviously much too high, or if dense blue or clearly-visible black smoke comes from the tailpipe for more than 5 seconds, the vehicle will fail. As a rule of thumb, blue smoke signifies oil being burnt (engine wear) while black smoke signifies unburnt fuel (dirty air cleaner element, or other carburettor or fuel system fault).

- An exhaust gas analyser capable of measuring carbon monoxide (CO) and hydrocarbons (HC) is now needed. If such an instrument cannot be hired or borrowed, a local garage may agree to perform the check for a small fee.

CO emissions (mixture)

- At the time of writing, the maximum CO level at idle is 3.5% for vehicles first used after August 1986 and 4.5% for older vehicles. From January 1996 a much tighter limit (around 0.5%) applies to catalyst-equipped vehicles first used from August 1992. If the CO level cannot be reduced far enough to pass the test (and the fuel and ignition systems are otherwise in good condition) then the carburettor is badly worn, or there is some problem in the fuel injection system or catalytic converter (as applicable).

HC emissions

- With the CO emissions within limits, HC emissions must be no more than 1200 ppm (parts per million). If the vehicle fails this test at idle, it can be re-tested at around 2000 rpm; if the HC level is then 1200 ppm or less, this counts as a pass.
- Excessive HC emissions can be caused by oil being burnt, but they are more likely to be due to unburnt fuel.

Diesel models

- The only emission test applicable to Diesel engines is the measuring of exhaust smoke density. The test involves accelerating the engine several times to its maximum unloaded speed.

Note: *It is of the utmost importance that the engine timing belt is in good condition before the test is carried out.*

- Excessive smoke can be caused by a dirty air cleaner element. Otherwise, professional advice may be needed to find the cause.

Buying spare parts and vehicle identification numbers

Buying spare parts

Spare parts are available from many sources; for example, Citroen garages, other garages and accessory shops, and motor factors. Our advice regarding spare part sources is as follows.

Officially-appointed Citroen garages - This is the best source for parts which are peculiar to your car, and are not generally available (eg complete cylinder heads, gearbox internal components, badges, interior trim etc). It is also the only place at which you should buy parts if the vehicle is still under warranty. To be sure of obtaining the correct parts, it will be necessary to give the storeman your car's vehicle identification number. If possible, take the old parts along for positive identification. Many parts are available under a factory exchange scheme - any parts returned should always be clean. It obviously makes good sense to go straight to the specialists on your car for this type of part, as they are best equipped to supply you.

Other garages and accessory shops - These are often very good places to buy materials and components needed for the maintenance of your car (eg oil filters, spark plugs, bulbs, drivebelts, oils and greases, touch-up paint, filler paste, etc). They also sell general accessories, usually have convenient opening hours, charge lower prices, and can often be found not far from home.

Motor factors - Good factors will stock all the more important components which wear out comparatively quickly (eg exhaust systems, brake pads, seals and hydraulic parts, clutch components, bearing shells, pistons, valves etc). Motor factors will often provide new or reconditioned components on a part-exchange basis - this can save a considerable amount of money.

Vehicle identification numbers

Modifications are a continuing and unpublicised process in vehicle manufacture, quite apart from major model changes. Spare parts manuals and lists are compiled upon a numerical basis, the individual vehicle identification numbers being essential to correct identification of the component concerned.

When ordering spare parts, always give as much information as possible. Quote the car model, year of manufacture, body and engine numbers as appropriate (see illustration).

The *vehicle identification plate* is stamped on a plate located under the bonnet on the lower right-hand wheel arch (see illustration).

The *chassis number* is stamped on the body panel under the bonnet on the right-hand side of the bulkhead on models produced up to 1993, or on the right-hand wheel arch on models produced from 1993 (see illustration).

The *paint code number* is located on the body panel under the bonnet on the left-hand upper wheel arch.

The *engine number* is stamped on a plate riveted to the front of the cylinder block (refer to Chapter 2A or 2B for further information).

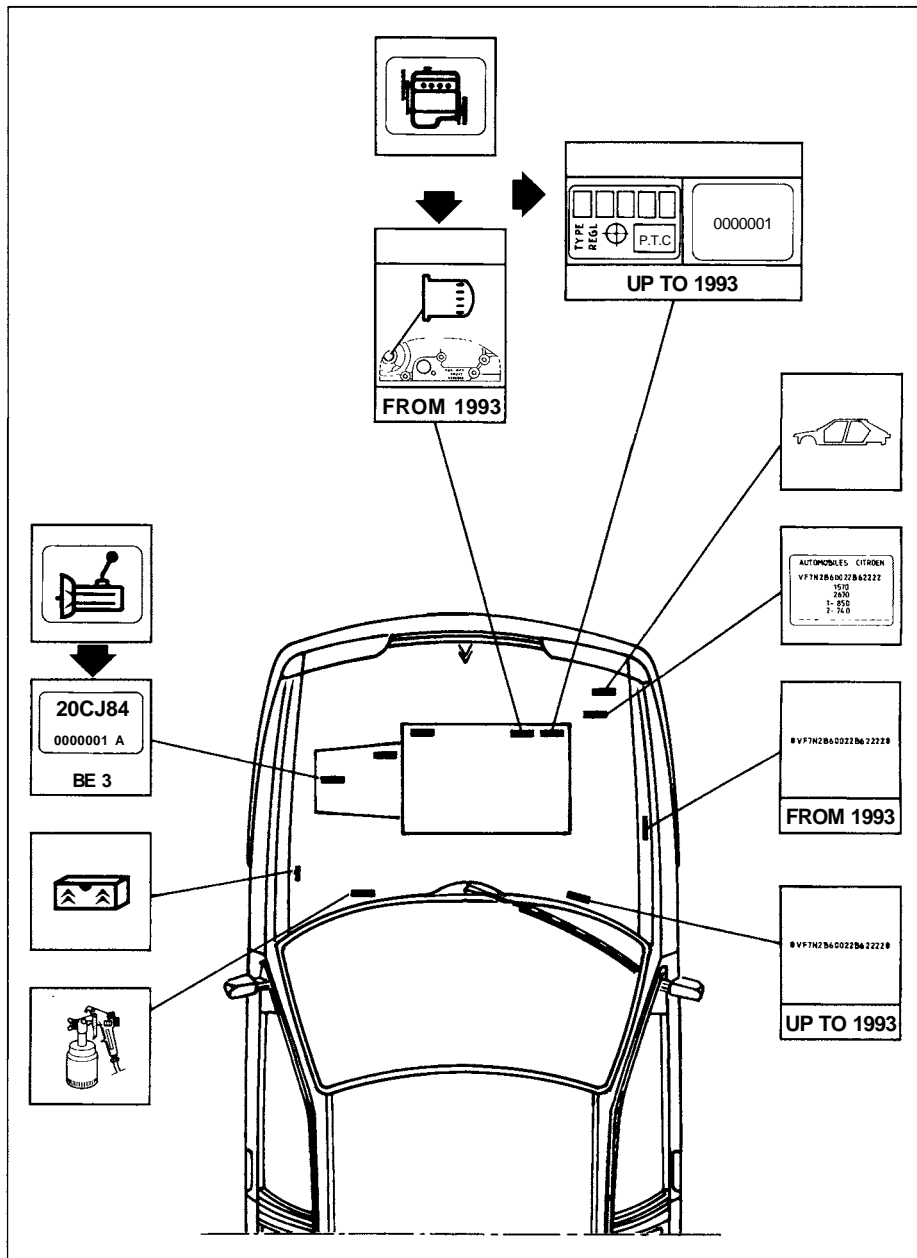

Vehicle identification number locations

Jacking, towing and wheel changing

Jacking

The jack supplied with the vehicle tool kit should only be used for changing the roadwheels - see "Wheel changing" later in this Section. When carrying out any other kind of work, raise the vehicle using a hydraulic jack, and always supplement the jack with axle stands positioned under the vehicle jacking points.

When using a hydraulic jack or axle stands, always position the jack head or axle stand head under one of the relevant jacking points (note that the jacking points for use with a hydraulic jack or axle stands are different to those for use with the vehicle jack) (**see illustrations**). **Do not** jack the vehicle under the sump or any of the steering or suspension components. **Never** work under, around, or near a raised vehicle, unless it is adequately supported in at least two places.

Note the following when using a hydraulic jack:

- (a) When raising the side of the vehicle, ensure that the load is taken by the raised

jacking plates on the sill panels (refer to the accompanying illustration) - **do not** jack under the body panel behind the sill panels.

- (b) When raising the front of the vehicle, use a suitable metal or strong wooden bar and wooden spacer blocks under the front suspension subframe (refer to the accompanying illustration).
- (c) When raising the rear of the vehicle, position the jack or axle stands under the rear suspension tubular crossmember (refer to the accompanying illustration).

Towing

Towing eyes are fitted to the front and rear of the vehicle for attachment of a tow rope. Note that, on certain models, plastic covers must be unclipped from the bumpers for access to the towing eyes (**see illustrations**). Always turn the ignition key to position "A" when the vehicle is being towed, so that the steering lock is released, and the direction indicator and brake lights are operational.

Before being towed, release the handbrake and place the gear lever in neutral on manual transmission models, or "N" on automatic transmission models. Note that greater-than-usual pedal pressure will be required to operate the brakes, since the vacuum servo unit is only operational with the engine running. Similarly, on models with power steering, greater-than-usual steering effort will be required.

Where possible, models with automatic transmission should ideally be towed with the front wheels off the ground, particularly if a transmission fault is suspected. If the vehicle is to be towed with its front wheels on the ground, it must always be towed forwards at speeds not exceeding 30 mph (50 km/h), or for a distance no further than 30 miles (50 km). Also note that, to avoid damaging the automatic transmission, the fluid level must be topped-up to the dipstick maximum mark as described in Chapter 1, then an extra 1.5 litres of fluid added. The excess fluid must be drained off before the vehicle is driven again.

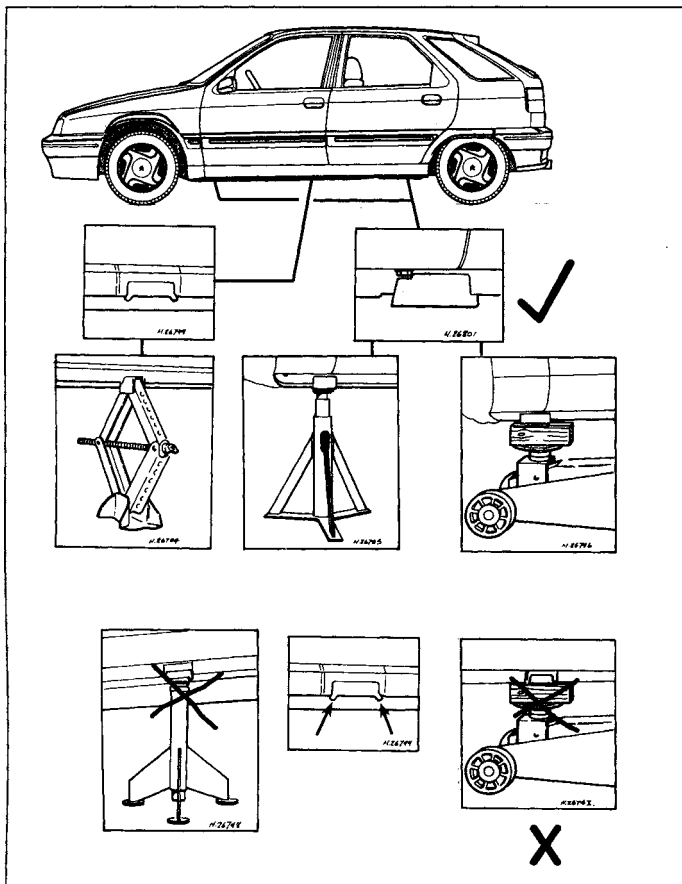

Side jacking points

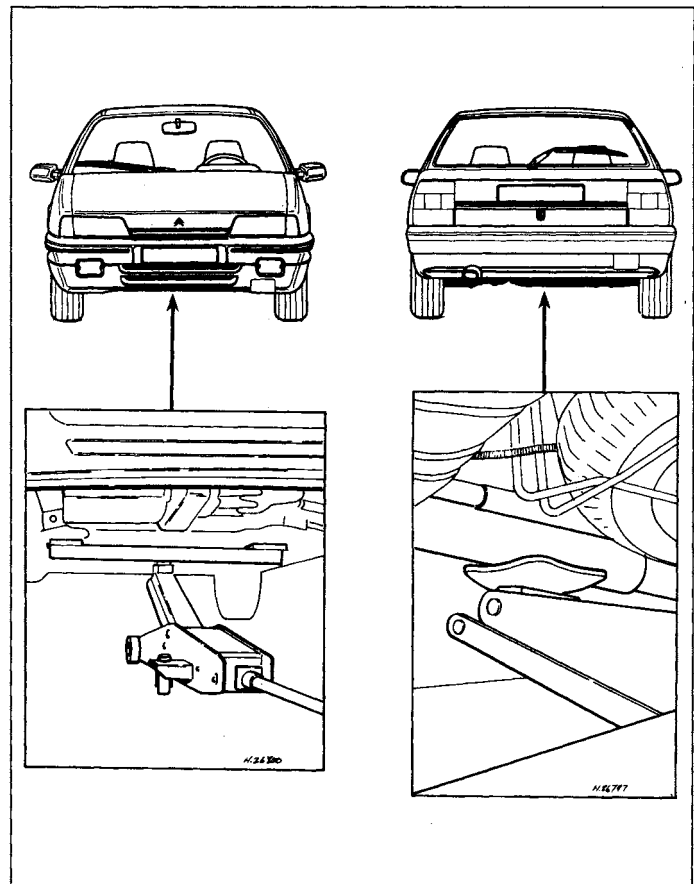

Front and rear jacking points

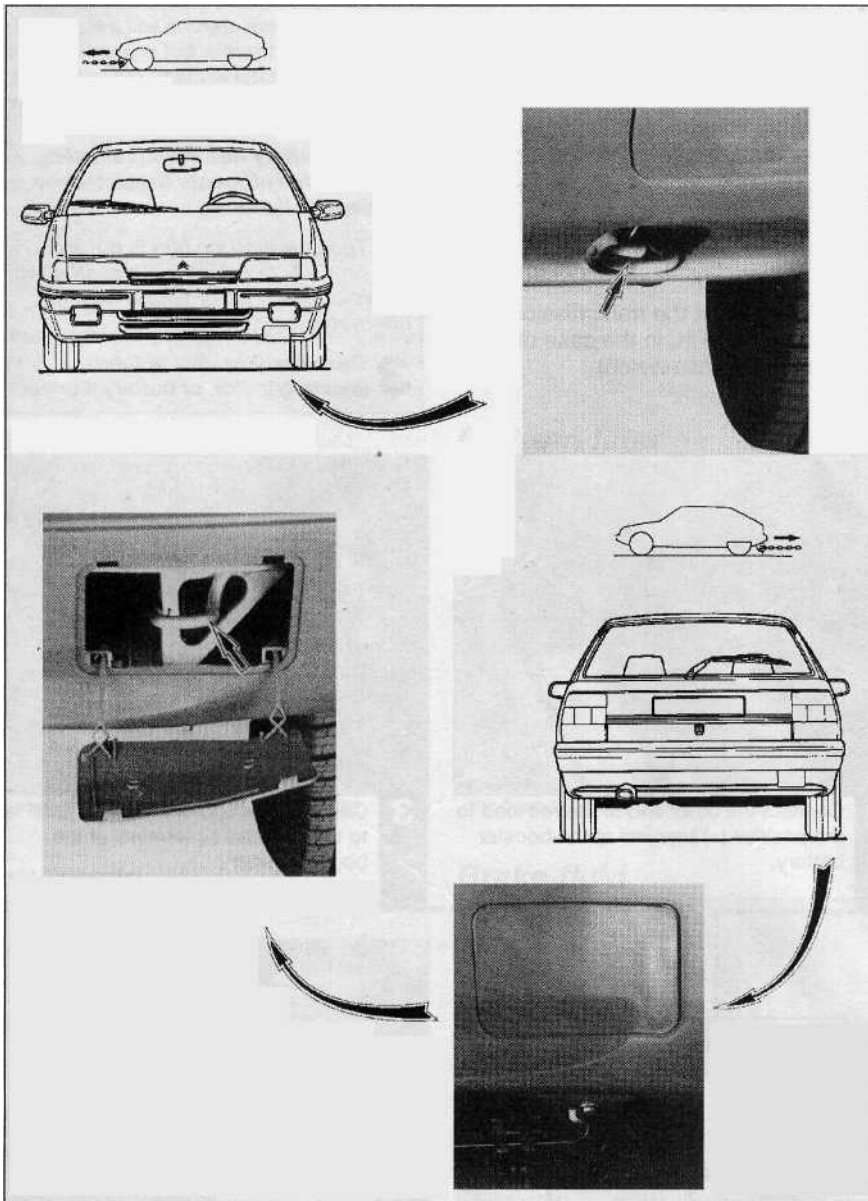

Front and rear towing eye locations

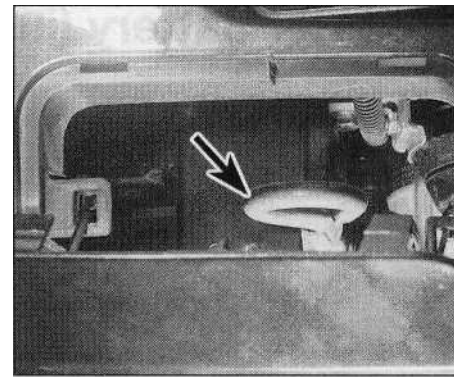

Cover removed to expose front towing eye (arrowed) - Volcane models

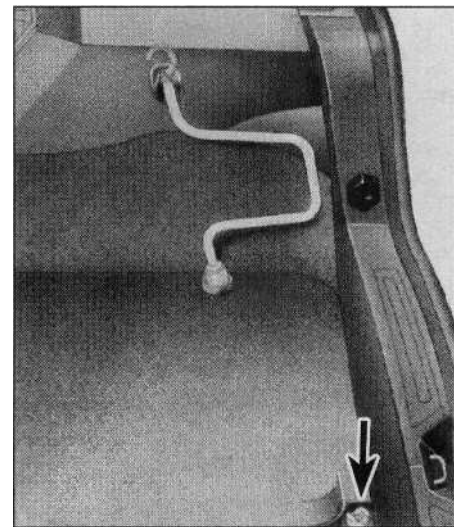

Wheel brace and spare wheel cradle retaining screw (arrowed) in luggage compartment

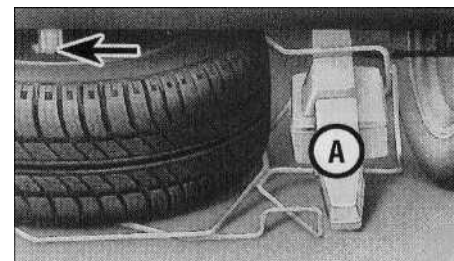

Spare wheel cradle retaining catch (arrowed) and jack case (A)

Wheel changing

The spare wheel and jack are located in a cradle under the rear of the vehicle. The cradle is lowered by turning the cradle retaining screw, located under the luggage compartment carpet, near the tailgate lock. The cradle retaining screw can be turned by engaging the end of the wheel brace (located in clips on the right-hand side of the luggage compartment) with the slot in the screw. Lift the cradle to release the retaining catch, then lower it for access to the spare wheel. Note that the jack is mounted inside a plastic case to protect it from road dirt and debris (**see illustrations**).

To change a wheel, remove the spare wheel and jack (as described previously), apply the handbrake and place chocks at the front and rear of the wheel diagonally opposite the one to be changed. A wheel chock is supplied with the tool kit, and is located in the well of the spare wheel. On automatic transmission models, place the selector lever in position "P". Make sure that the vehicle is located on firm level ground, and then slightly loosen the wheel bolts with the brace provided (where applicable, remove the wheel trim first).

Locate the jack head in the jacking point on the relevant side of the vehicle to be raised, and raise the jack by turning the screw using the wheel brace. When the wheel is clear of

the ground, remove the bolts and lift off the wheel. Fit the spare wheel, and moderately tighten the bolts. Lower the vehicle and then tighten the bolts fully. Refit the trim where applicable. If possible, check the tyre pressure on the spare wheel.

Remove the chocks and stow the jack, tools, and the damaged wheel. Have the damaged tyre or wheel repaired or renewed as soon as possible.

Booster battery (jump) starting

When jump-starting a car using a booster battery, observe the following precautions:

- A) Before connecting the booster battery, make sure that the ignition is switched off.
- B) Ensure that all electrical equipment (lights, heater, wipers, etc) is switched off.
- C) Make sure that the booster battery is the same voltage as the discharged one in the vehicle.
- D) If the battery is being jump-started from the battery in another vehicle, the two vehicles **MUST NOT TOUCH** each other.
- E) Make sure that the transmission is in neutral (or PARK, in the case of automatic transmission).



Jump starting will get you out of trouble, but you must correct whatever made the battery go flat in the first place. There are three possibilities:

- 1** *The battery has been drained by repeated attempts to start, or by leaving the lights on.*
- 2** *The charging system is not working properly (alternator drivebelt slack or broken, alternator wiring fault or alternator itself faulty).*
- 3** *The battery itself is at fault (electrolyte low, or battery worn out).*

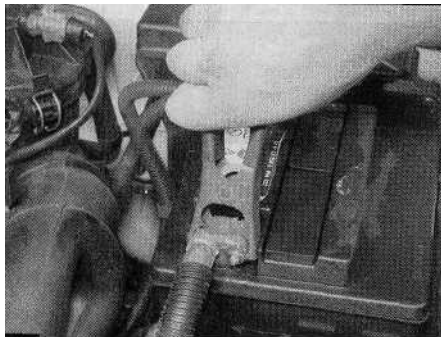

- 1** Connect one end of the red jump lead to the positive (+) terminal of the flat battery

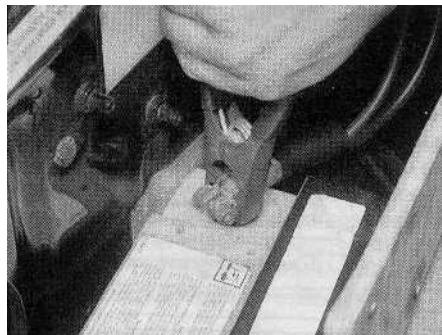

- 2** Connect the other end of the red lead to the positive (+) terminal of the booster battery.

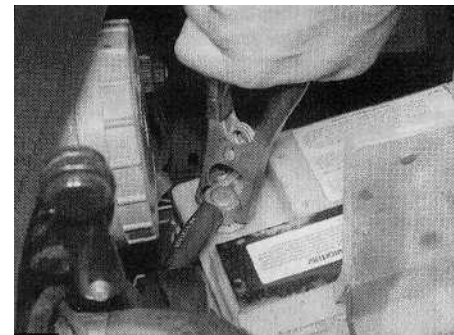

- 3** Connect one end of the black jump lead to the negative (-) terminal of the booster battery

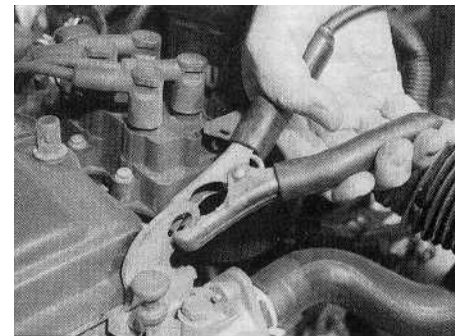
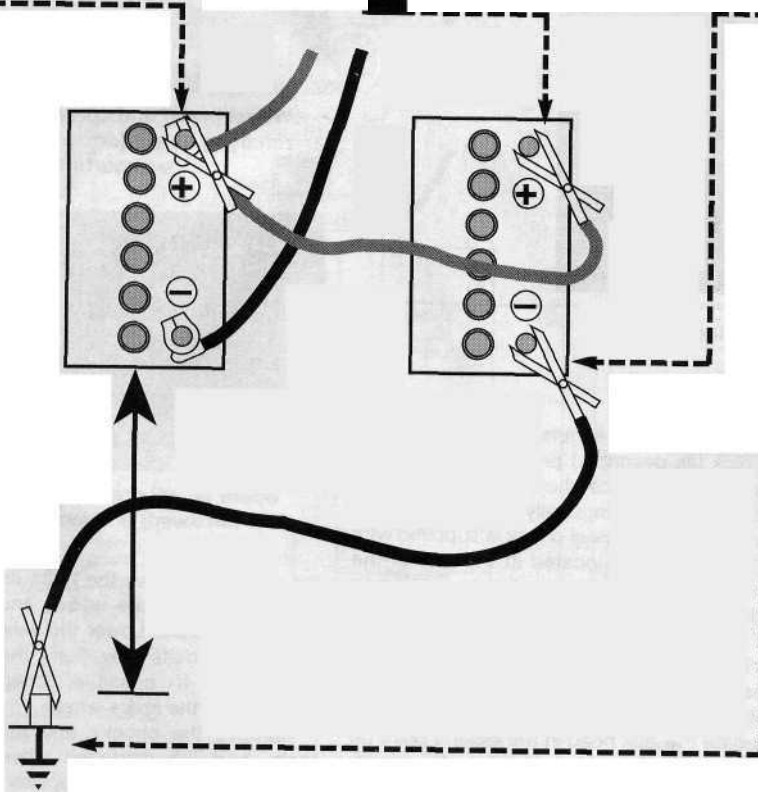

- 4** Connect the other end of the black jump lead to a bolt or bracket on the engine block, well away from the battery, on the vehicle to be started

- 5** Make sure that the jump leads will not come into contact with the fan, drivebelts or other moving parts of the engine.

- 6** Start the engine using the booster battery, then with the engine running at idle speed, disconnect the jump leads in the reverse order of connection.

Identifying leaks

Puddles on the garage floor or drive, or obvious wetness under the bonnet or underneath the car, suggest a leak that needs investigating. It can sometimes be difficult to decide where the leak is coming from, especially if the engine bay is very dirty already. Leaking oil or fluid can also be blown rearwards by the passage of air under the car, giving a false impression of where the problem lies.



Warning: Most automotive oils and fluids are poisonous. Wash them off skin, and change out of contaminated clothing, without delay.



The smell of a fluid leaking from the car may provide a clue to what's leaking. Some fluids are distinctively coloured.

It may help to clean the car carefully and to park it over some clean paper overnight as an aid to locating the source of the leak. Remember that some leaks may only occur while the engine is running.

Sump oil

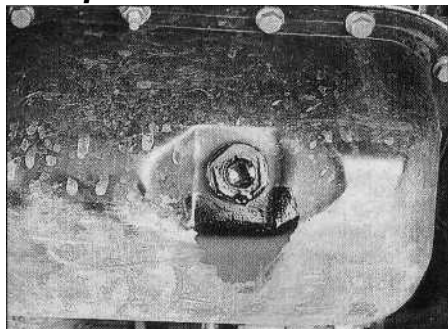

Engine oil may leak from the drain plug...

Oil from filter

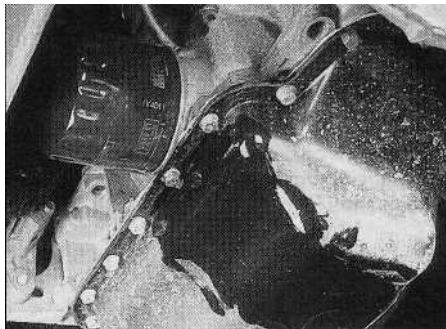

...or from the base of the oil filter.

Gearbox oil

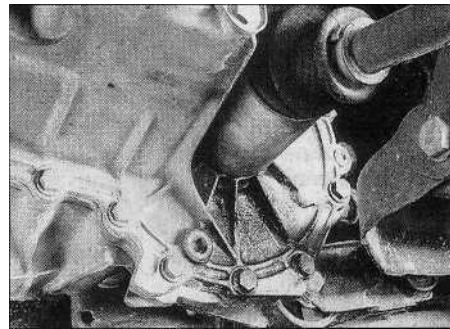

Gearbox oil can leak from the seals at the inboard ends of the driveshafts.

Antifreeze

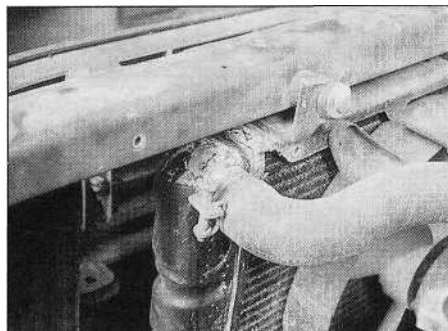

Leaking antifreeze often leaves a crystalline deposit like this.

Brake fluid

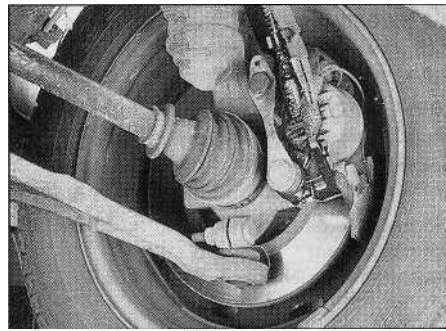

A leak occurring at a wheel is almost certainly brake fluid.

Power steering fluid

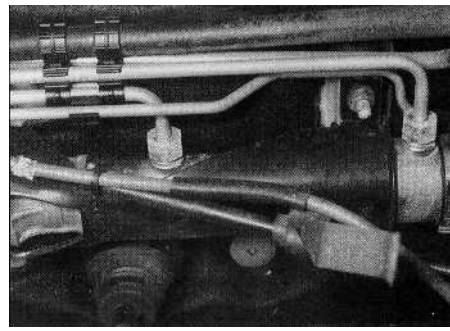

Power steering fluid may leak from the pipe connectors on the steering rack.

Radio/cassette unit anti-theft system - precaution

The radio/cassette unit fitted as standard equipment by Citroen is equipped with a built-in security code, to deter thieves. If the power source to the unit is cut, the anti-theft system will activate. Even if the power source is immediately reconnected, the radio/cassette unit will not function until the correct security code has been entered. Therefore, if you do not know the correct security code for the radio/cassette unit *do not* disconnect either of the battery terminals, or remove the radio/cassette unit from the vehicle.

To enter the security code, first switch the unit on; the display will show "Cod". The security

code can then be entered using buttons 1 to 4 on the unit; each button alters the corresponding digit of the code. **Note:** *There is no facility on the radio display to show the number 0 for the first digit of the security code. For the first digit, 0 is indicated by a blank.* Once the correct code is displayed, press the "up" section of the four-way tuning button to enter the code.

If an incorrect code is entered, the display will show three dashes, after which the radio will be locked for 10 seconds. On the first two attempts, after 10 seconds the radio display will show the "Cod" prompt again, and allow you to enter the security code again. However,

if the correct security code is not entered on the third attempt, the unit will be locked for 1 hour. To make any further attempts, the unit must be switched on and left untouched for approximately 1 hour before the display shows the "Cod" prompt again, and allows you to re-enter the security code. Note that after twenty attempts, the unit will become permanently locked.

If this happens, or if the security code is lost or forgotten, seek the advice of your Citroen dealer. On presentation of proof of ownership, a Citroen dealer will be able to unlock the unit and provide you with a new security code.

Conversion Factors

Length (distance)

| | | |
|-------------|---------------------------|------------------------|
| Inches (in) | x 25.4 = Millimetres (mm) | x 0.0394 = Inches (in) |
| Feet (ft) | x 0.305 = Metres (m) | x 3.281 = Feet (ft) |
| Miles | x 1.609 = Kilometres (km) | x 0.621 = Miles |

Volume (capacity)

| | | |
|--|---|--|
| Cubic inches (cu in; in ³) | x 16.387 = Cubic centimetres (cc; cm ³) | x 0.061 = Cubic inches (cu in; in ³) |
| Imperial pints (Imp pt) | x 0.568 = Litres (l) | x 1.76 = Imperial pints (Imp pt) |
| Imperial quarts (Imp qt) | x 1.137 = Litres (l) | x 0.88 = Imperial quarts (Imp qt) |
| Imperial quarts (Imp qt) | x 1.201 = US quarts (US qt) | x 0.833 = Imperial quarts (Imp qt) |
| US quarts (US qt) | x 0.946 = Litres (l) | x 1.057 = US quarts (US qt) |
| Imperial gallons (imp gal) | x 4.546 = Litres (l) | x 0.22 = Imperial gallons (Imp gal) |
| Imperial gallons (Imp gal) | x 1.201 = US gallons (US gal) | x 0.833 = Imperial gallons (Imp gal) |
| US gallons (US gal) | x 3.785 = Litres (l) | x 0.264 = US gallons (US gal) |

Mass (weight)

| | | |
|-------------|--------------------------|-----------------------|
| Ounces (oz) | x 28.35 = Grams (g) | x 0.035 = Ounces (oz) |
| Pounds (lb) | x 0.454 = Kilograms (kg) | x 2.205 = Pounds (lb) |

Force

| | | |
|------------------------|-----------------------------------|----------------------------------|
| Ounces-force (ozf; oz) | x 0.278 = Newtons (N) | x 3.6 = Ounces-force (ozf; oz) |
| Pounds-force (lbf; lb) | x 4.448 = Newtons (N) | x 0.225 = Pounds-force (lbf; lb) |
| Newtons (N) | x 0.1 = Kilograms-force (kgf; kg) | x 9.81 = Newtons (N) |

Pressure

| | | |
|---|---|--|
| Pounds-force per square inch (psi; lbf/in ² ; lb/in ²) | x 0.070 = Kilograms-force per square centimetre (kgf/cm ² ; kg/cm ²) | x 14.223 = Pounds-force per square inch (psi; lbf/in ² ; lb/in ²) |
| Pounds-force per square inch (psi; lbf/in ² ; lb/in ²) | x 0.068 = Atmospheres (atm) | x 14.696 = Pounds-force per square inch (psi; lbf/in ² ; lb/in ²) |
| Pounds-force per square inch (psi; lbf/in ² ; lb/in ²) | x 0.069 = Bars | x 14.5 = Pounds-force per square inch (psi; lbf/in ² ; lb/in ²) |
| Pounds-force per square inch (psi; lbf/in ² ; lb/in ²) | x 6.895 = Kilopascals (kPa) | x 0.145 = Pounds-force per square inch (psi; lbf/in ² ; lb/in ²) |
| Kilopascals (kPa) | x 0.01 = Kilograms-force per square centimetre (kgf/cm ² ; kg/cm ²) | x 98.1 = Kilopascals (kPa) |
| Millibar (mbar) | x 100 = Pascals (Pa) | x 0.01 = Millibar (mbar) |
| Millibar (mbar) | x 0.0145 = Pounds-force per square inch (psi; lbf/in ² ; lb/in ²) | x 68.947 = Millibar (mbar) |
| Millibar (mbar) | x 0.75 = Millimetres of mercury (mmHg) | x 1.333 = Millibar (mbar) |
| Millibar (mbar) | x 0.401 = Inches of water (inH ₂ O) | x 2.491 = Millibar (mbar) |
| Millimetres of mercury (mmHg) | x 0.535 = Inches of water (inH ₂ O) | x 1.868 = Millimetres of mercury (mmHg) |
| Inches of water (inH ₂ O) | x 0.036 = Pounds-force per square inch (psi; lbf/in ² ; lb/in ²) | x 27.68 = Inches of water (inH ₂ O) |

Torque (moment of force)

| | | |
|-------------------------------------|--|---|
| Pounds-force inches (lbf in; lb in) | x 1.152 = Kilograms-force centimetre (kgf cm; kg cm) | x 0.868 = Pounds-force inches (lbf in; lb in) |
| Pounds-force inches (lbf in; lb in) | x 0.113 = Newton metres (Nm) | x 8.85 = Pounds-force inches (lbf in; lb in) |
| Pounds-force inches (lbf in; lb in) | x 0.083 = Pounds-force feet (lbf ft; lb ft) | x 12 = Pounds-force inches (lbf in; lb in) |
| Pounds-force feet (lbf ft; lb ft) | x 0.138 = Kilograms-force metres (kgf m; kg m) | x 7.233 = Pounds-force feet (lbf ft; lb ft) |
| Pounds-force feet (lbf ft; lb ft) | x 1.356 = Newton metres (Nm) | x 0.738 = Pounds-force feet (lbf ft; lb ft) |
| Newton metres (Nm) | x 0.102 = Kilograms-force metres (kgf m; kg m) | x 9.804 = Newton metres (Nm) |

Power

| | | |
|-----------------|---------------------|----------------------------|
| Horsepower (hp) | x 745.7 = Watts (W) | x 0.0013 = Horsepower (hp) |
|-----------------|---------------------|----------------------------|

Velocity (speed)

| | | |
|--------------------------------|--|--|
| Miles per hour (miles/hr; mph) | x 1.609 = Kilometres per hour (km/hr; kph) | x 0.621 = Miles per hour (miles/hr; mph) |
|--------------------------------|--|--|

Fuel consumption*

| | | |
|------------------------|---------------------------------------|----------------------------------|
| Miles per gallon (mpg) | x 0.354 = Kilometres per litre (km/l) | x 2.825 = Miles per gallon (mpg) |
|------------------------|---------------------------------------|----------------------------------|

Temperature

Degrees Fahrenheit = (°C x 1.8) + 32

Degrees Celsius (Degrees Centigrade; °C) = (°F - 32) x 0.56





* It is common practice to convert from miles per gallon (mpg) to litres/100 kilometres (l/100km), where mpg x 1/100 km = 282

Chapter 1 Routine maintenance and servicing

Contents

| | | | |
|---|----|--|--------------------|
| Air conditioning system refrigerant check | 14 | Hose and fluid leak check | 9 |
| Air filter renewal | 26 | Idle speed and mixture check and adjustment | 19 |
| Automatic transmission fluid level check | 10 | Ignition system check | 18 |
| Automatic transmission fluid renewal | 29 | intensive maintenance | 2 |
| Auxiliary drivebelt checking and renewal | 21 | Introduction | 1 |
| Battery check | 6 | Manual transmission oil level check | 28 |
| Brake fluid renewal | 30 | Manual transmission oil renewal | 34 |
| Clutch adjustment check and control mechanism lubrication | 22 | Rear brake pad condition check - models with rear disc brakes | 24 |
| Coolant renewal | 31 | Rear brake shoe condition check - models with rear drum brakes | 23 |
| Driveshaft gaiter check | 12 | Road test | 25 |
| Electrical system check | 5 | Spark plug renewal | 16 |
| Emission control systems check | 20 | Specifications | See end of Chapter |
| Engine oil and filter renewal | 8 | Steering and suspension check | 11 |
| Fluid level checks | 3 | Timing belt renewal | 33 |
| Front brake pad condition check | 13 | Tyre checks | 4 |
| Fuel filter renewal - carburettor models | 17 | Valve clearance check and adjustment -1124 cc and 1360 cc models | 15 |
| Fuel filter renewal - fuel injection models | 32 | Wiper blade check | 7 |
| Hinge and lock lubrication | 27 | | |

Degrees of difficulty

| | | | | |
|--|---|---|--|---|
| <p>Easy, suitable for novice with little experience</p>  | <p>Fairly easy, suitable for beginner with some experience</p>  | <p>Fairly difficult, suitable for competent DIY mechanic</p>  | <p>Difficult, suitable for experienced DIY mechanic</p>  | <p>Very difficult, suitable for expert DIY or professional</p>  |
|--|---|---|--|---|

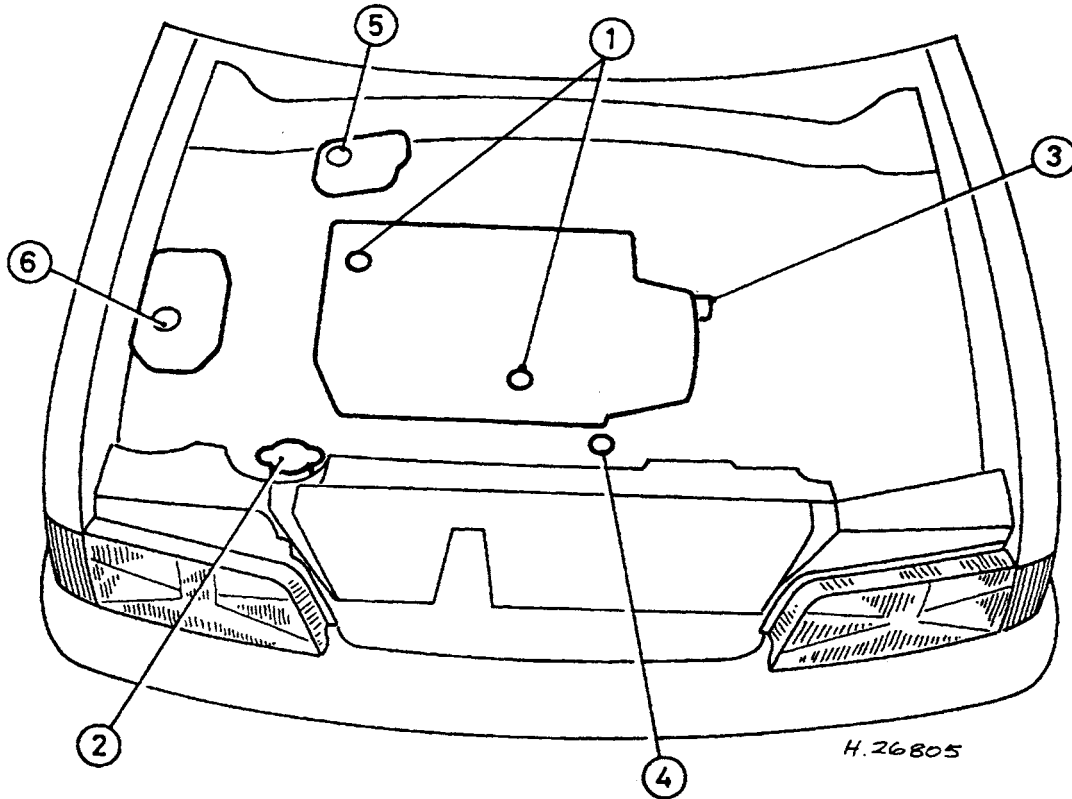

Lubricants and fluids

| Component or system | Lubricant type/specification |
|--------------------------|--|
| 1 Engine | Multigrade engine oil, viscosity SAE 10W/40or 15W/50, to API SG/CD |
| 2 Cooling system | Ethylene glycol-based antifreeze |
| 3 Manual transmission | Total transmission BV75/80W |
| 4 Automatic transmission | Dexron type IIATF |
| 5 Braking system | Total Universal Brake and Clutch Fluid |
| 6 Power steering | Dexron type II ATF |

Capacities

Engine oil

Excluding filter:

| | |
|----------------------------|------------|
| 1124 cc and 1360 cc models | 3.2 litres |
| 1580 cc and 1905 cc models | 4.5 litres |
| 1761 cc models | 4.4 litres |
| 1998 cc models | 4.7 litres |

Including filter:

| | |
|----------------------------|------------|
| 1124 cc and 1360 cc models | 3.5 litres |
| 1580 cc and 1905 cc models | 5.0 litres |
| 1761 cc models | 4.9 litres |
| 1998 cc models | 5.4 litres |

Difference between "MIN" and "MAX" dipstick marks (approximate):

| | |
|---------------------------------|------------|
| Models without air conditioning | 1.5 litres |
| Models with air conditioning | 1.3 litres |

Cooling system

1124 cc and 1360 cc models:

| | |
|---------------------------------|------------|
| Models without air conditioning | 6.5 litres |
| Models with air conditioning | 7.5 litres |

1580 cc and 1905 cc models:

| | |
|------------------------------------|------------|
| Models with manual transmission | 7.5 litres |
| Models with automatic transmission | 8.0 litres |
| 1761 cc models | 8.0 litres |
| 1998 cc models | 8.5 litres |

Transmission

| | |
|------------------|------------|
| Manual | 2.0 litres |
| Automatic: | |
| From dry | 6.2 litres |
| Drain and refill | 2.4 litres |

Power-assisted steering **1.7 litres**

Fuel tank **.56 litres**

Maintenance schedule

1 The maintenance intervals in this manual are provided on the assumption that you, not the dealer, will be carrying out the work. These are the minimum maintenance intervals recommended by the manufacturer for vehicles driven daily. If you wish to keep your vehicle in peak condition at all times, you may wish to perform some of these procedures more often. We encourage frequent maintenance, because it enhances the efficiency, performance and resale value of your vehicle. If the vehicle is driven in dusty areas, used to tow a trailer, or is

driven frequently at slow speeds (idling in traffic) or on short journeys, more frequent maintenance intervals are recommended.

2 Vehicles which cover a low mileage (less than 12 000 miles/20 000 km per year) should be serviced following the time interval instead of the mileage interval. This is necessary because many lubricants and fluids, as well as some components, deteriorate with time as much as with use.

3 When the vehicle is new, it should be serviced by a factory-authorised dealer service department, in order to preserve the factory warranty.

Every 250 miles (400 km) or weekly

- Check the engine oil level (Section 3)
- Check the engine coolant level (Section 3)
- Check the brake fluid level (Section 3)
- Check the power steering fluid level (Section 3)
- Check the screen washer fluid level (Section 3)
- Check the tyres for wear or damage (Section 4)
- Check and adjust the tyre pressures (Section 4)
- Check the condition of the battery (Section 6)
- Check the operation of the horn, all lights, and the wipers and washers (Sections 5 and 7)

- Check the condition of the rear brake shoes, and renew if necessary - rear drum brake models (Section 23)
- Check the condition of the rear disc brake pads, and renew if necessary - rear disc brake models (Section 24)
- Carry out a road test (Section 25)

**The manufacturer suggests this operation at the first 12 000 mile service only. After that, checking and adjusting of the valve clearances is not part of the recommended maintenance schedule.*

Every 48 000 miles (80 000 km)

- Renew the timing belt (Section 33)
- Note: *On all 1998 cc models, Citroen have extended the timing belt renewal interval to 72 000 miles. However, it is also stated that, should the vehicle be subjected to intensive use, ie. mainly short journeys or a lot of stop-start driving, the belt should be renewed every 36 000 miles. The actual belt renewal interval is therefore very much up to the individual owner. That being said, it is highly recommended to err on the side of safety, and renew the belt at the earlier interval. It is certainly not advisable to exceed the 48 000 mile interval recommended for all other models, bearing in mind the drastic consequences resulting from belt failure.*

Every 6000 miles (10 000 km) or 6 months - whichever comes first

- Renew the engine oil and filter* (Section 8)
- Check all components and hoses for fluid leaks (Section 9)
- Check the automatic transmission fluid level (Section 10)
- Check the steering and suspension components for condition and security (Section 11)
- Check the condition of the driveshaft gaiters (Section 12)
- Check the condition of the front brake pads, and renew if necessary (Section 13)

The manufacturer specifies that the oil filter should be renewed at the first 6000 mile service, and then at 12 000 miles intervals, with only the oil being drained and renewed every 6000 miles. Owners may prefer to carry out filter renewal at the 6000-mile interval, as a precautionary task.

Every 72 000 miles (116 000 km)

- Renew the manual transmission oil (Section 34)

Every 12 000 miles (20 000 km) or 12 months - whichever comes first

In addition to all the items listed above, carry out the following:

- Check the condition of the air conditioning system refrigerant - where applicable (see Section 14)
- Check and, if necessary, adjust the valve clearances - 1124 cc and 1360 cc models (Section 15)*
- Renew the spark plugs (Section 16)
- Renew the fuel filter - carburettor models (Section 17)
- Check the ignition system and ignition timing (Section 18)
- Check the idle speed and mixture adjustment (Section 19)
- Check the condition of the emission control system hoses and components (Section 20)
- Check the condition of the auxiliary drivebelt, and renew if necessary (Section 21)
- Check the clutch mechanism adjustment (Section 22)
- Lubricate the clutch control mechanism (Section 22)

Every 18 000 miles (30 000 km) or 18 months - whichever comes first

In addition to all the items listed above, carry out the following:

- Renew the air filter (Section 26)
- Lubricate all hinges and locks (Section 27)

Every 24 000 miles (40 000 km) or 2 years - whichever comes first

In addition to all the items listed above, carry out the following:

- Check the manual transmission oil level, and top-up if necessary (Section 28)
- Renew the automatic transmission fluid (Section 29)
- Renew the brake fluid (Section 30)

Every 40 000 miles (60 000 km) or 2 years - whichever comes first

- Renew the coolant (Section 31)
- Renew the fuel filter - fuel injection models (Section 32)